

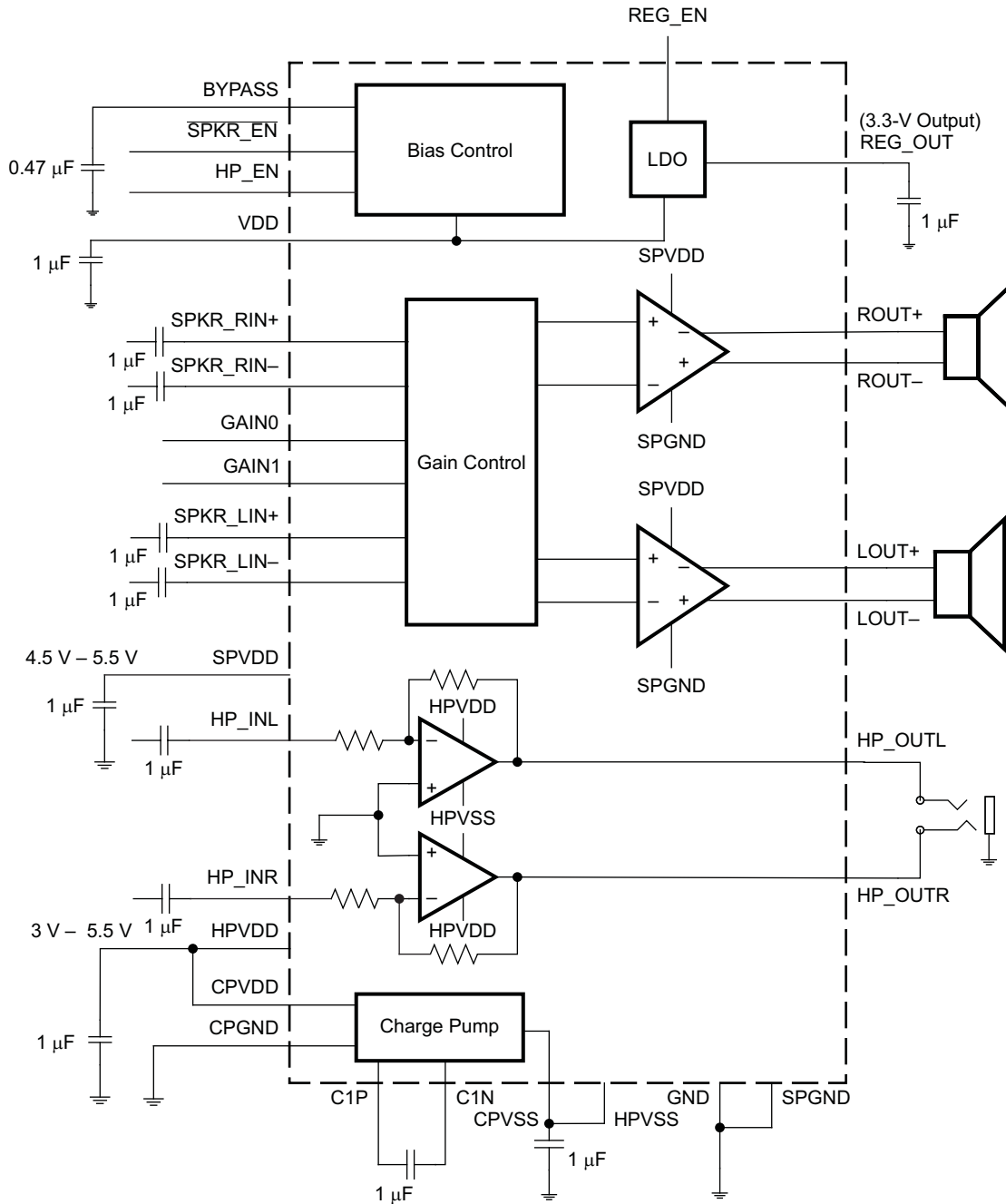

These devices have limited built-in ESD protection. The leads should be shorted together or the device placed in conductive foam during storage or handling to prevent electrostatic damage to the MOS gates.

Functional Block Diagram



AVAILABLE PACKAGE OPTIONS

T _A	PACKAGED DEVICE ⁽¹⁾⁽²⁾ 32-Pin QFN (RHB)	SYMBOL
–40°C to 85°C	TPA6041A4RHB	RHB

- (1) The RHB package is available taped and reeled. To order a taped and reeled part, add the suffix R to the part number (e.g., TPA6041A4RHBR).
- (2) For the most current package and ordering information, see the Package Option Addendum at the end of this document, or see the TI website at www.ti.com.

**TPA6041A4RHB
(TOP VIEW)**

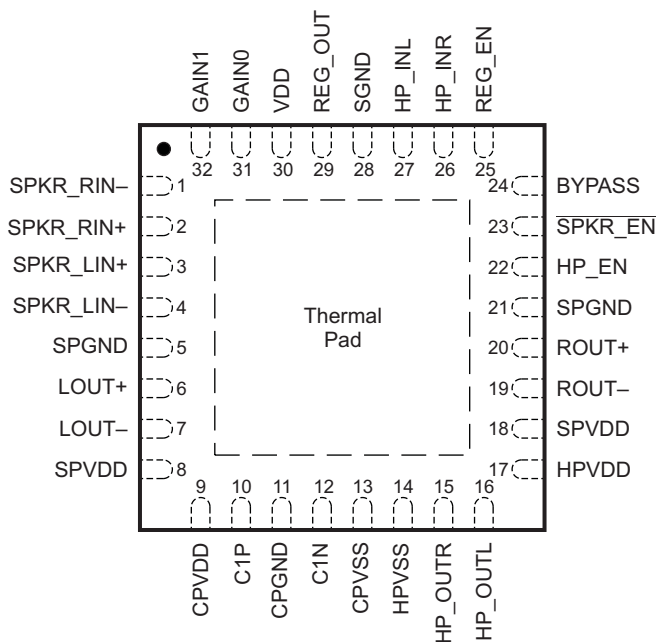

TERMINAL FUNCTIONS

TERMINAL NAME	NO.	I/O/P	DESCRIPTION
SPKR_RIN–	1	I	Right-channel negative differential audio input for speaker amplifier
SPKR_RIN+	2	I	Right-channel positive differential audio input for speaker amplifier
SPKR_LIN+	3	I	Left-channel positive differential audio input for speaker amplifier
SPKR_LIN–	4	I	Left-channel negative differential audio input for speaker amplifier
SPGND	5, 21	P	Speaker power ground
LOUT+	6	O	Left-channel positive audio output
LOUT–	7	O	Left-channel negative audio output
SPVDD	8, 18	P	Supply voltage terminal for speaker amplifier
CPVDD	9	P	Charge pump positive supply, connect to HPVDD via star connection
C1P	10	I/O	Charge pump flying capacitor positive terminal
CPGND	11	P	Charge pump ground
C1N	12	I/O	Charge pump flying capacitor negative terminal
CPVSS	13	P	Charge pump output (negative supply for headphone amplifier), connect to HPVSS
HPVSS	14	P	Headphone amplifier negative supply, connect to CPVSS
HP_OUTR	15	O	Right-channel capacitor-free headphone output
HP_OUTL	16	O	Left-channel capacitor-free headphone output
HPVDD	17	P	Headphone amplifier supply voltage, connect to CPVDD
ROUT–	19	O	Right-channel negative audio output

TERMINAL FUNCTIONS (continued)

TERMINAL		I/O/P	DESCRIPTION
NAME	NO.		
ROUT+	20	O	Right-channel positive audio output
HP_EN	22	I	Headphone channel enable logic input; active high enable. HIGH=ENABLE.
SPKR_EN	23	I	Speaker channel enable logic input; active low enable. LOW=ENABLE.
BYPASS	24	P	Common-mode bias voltage for speaker preamplifiers
REG_EN	25	I	Enable pin (Active HIGH) for turning on/off LDO. HIGH=ENABLE
HP_INR	26	I	Headphone right-channel audio input
HP_INL	27	I	Headphone left-channel audio input
SGND	28	P	Signal ground, connect to CPGND and SPGND
REG_OUT	29	O	Regulated 3.3-V output
VDD	30	P	Positive power supply
GAIN0	31	I	Bit 0, MSB, of gain select bits
GAIN1	32	I	Bit 1, LSB, of gain select bits
Thermal Pad	Die Pad	P	Solder the thermal pad on the bottom of the QFN package to the GND plane of the PCB. It is required for mechanical stability and will enhance thermal performance.

ABSOLUTE MAXIMUM RATINGS

over operating free-air temperature range (unless otherwise noted)⁽¹⁾

		VALUE	UNIT
Supply voltage	HPVDD, VDD, SPVDD, CPVDD	–0.3 to 6	V
V _I Input voltage	SPKR_LIN+, SPKR_LIN-, SPKR_RIN+, SPKR_RIN-, HP_EN, GAIN0, GAIN1, SPK_EN, REG_EN	–0.3 to 6.3	V
	HP_INL, HP_INR HP Enabled	–3.5 to 3.5	
	HP_INL, HP_INR HP not Enabled	–0.3 to 3.5	
Continuous total power dissipation		See Dissipation Rating Table	
T _A Operating free-air temperature range		–40 to 85	°C
T _J Operating junction temperature range		–40 to 150	°C
T _{stg} Storage temperature range		–65 to 150	°C
Electrostatic discharge	HBM for HP_OUTL and HP_OUTR	8	kV
Electrostatic discharge, all other pins	CDM	500	V
	HBM	2	kV

(1) Stresses beyond those listed under *absolute maximum ratings* may cause permanent damage to the device. These are stress ratings only, and functional operations of the device at these or any other conditions beyond those indicated under *recommended operating conditions* is not implied. Exposure to absolute-maximum-rated conditions for extended periods may affect device reliability.

DISSIPATION RATINGS

PACKAGE ⁽¹⁾	T _A ≤ 25°C	DERATING FACTOR	T _A = 70°C	T _A = 85°C
RHB	5.06 W	40 mW/°C	4.04 W	3.23 W

(1) The PowerPAD™ must be soldered to a thermal land on the printed-circuit board. Refer to the Texas Instruments document, PowerPAD™ Thermally Enhanced Package application report (literature number SLMA002) for more information regarding the PowerPAD™ package.

RECOMMENDED OPERATING CONDITIONS

		MIN	MAX	UNIT
Supply voltage	VDD, SPVDD	4.5	5.5	V
Supply voltage	HPVDD, CPVDD	3	5.5	V
V _{IH} High-level input voltage	SPKR_EN, HP_EN, GAIN0, GAIN1, REG_EN	2		V

RECOMMENDED OPERATING CONDITIONS (continued)

		MIN	MAX	UNIT
V _{IL}	Low-level input voltage	SPKR_EN, HP_EN, GAIN0, GAIN1, REG_EN		0.8 V
T _A	Operating free-air temperature	-40	85	°C

GENERAL DC ELECTRICAL CHARACTERISTICS

T_A = 25°C, VDD = SPVDD = HPVDD = CPVDD = 5 V (unless otherwise noted)

PARAMETER	TEST CONDITIONS	MIN	TYP	MAX	UNIT	
I _{IH}	High-level input current	SPKR_EN, HP_EN, GAIN0, GAIN1, REG_EN = VDD		0.02	1	μA
I _{IL}	Low-level input current	SPKR_EN, HP_EN, GAIN0, GAIN1, REG_EN = 0 V		0.02	1	μA
I _{DD(Speaker)}	Supply current, speaker amplifier ONLY enabled	SPKR_EN = 0 V, HP_EN = REG_EN = 0 V		5	12	mA
I _{DD(HP)}	Supply current, headphone amplifier ONLY enabled	SPKR_EN = HP_EN = 2 V, REG_EN = 0 V		7.5	14	mA
I _{DD(REG)}	Supply current, regulator ONLY enabled	SPKR_EN = REG_EN = 2 V, HP_EN = 0 V		0.65	1	mA
I _{DD(SD)}	Supply current, shutdown mode	SPKR_EN = 2 V, HP_EN = REG_EN = 0 V		2.5	5	μA

SPEAKER AMPLIFIER DC CHARACTERISTICS

T_A = 25°C, VDD = SPVDD = 5 V, R_L = 4 Ω, Gain = 10 dB (unless otherwise noted)

PARAMETER	TEST CONDITIONS	MIN	TYP	MAX	UNIT	
V _{OO}	Output offset voltage (measured differentially)	Inputs AC-coupled to GND, Gain = 10 dB		0.5	10	mV
PSRR	Power supply rejection ratio	VDD = SPVDD = 4.5 V to 5.5 V		-60	-74	dB

SPEAKER AMPLIFIER AC CHARACTERISTICS

T_A = 25°C, VDD = SPVDD = 5 V, R_L = 4 Ω, Gain = 10 dB (unless otherwise noted)

PARAMETER	TEST CONDITIONS	MIN	TYP	MAX	UNIT		
P _O	Output power	THD+N = 1%, f = 1 kHz, R _L = 8 Ω		1.3	W		
		THD+N = 10%, f = 1 kHz, R _L = 8 Ω		1.6			
		THD+N = 1%, f = 1 kHz, R _L = 4 Ω		2.1			
		THD+N = 10%, f = 1 kHz, R _L = 4 Ω		2.6			
THD+N	Total harmonic distortion plus noise	P _O = 1 W, R _L = 8 Ω, f = 20 Hz to 20 kHz		0.06%			
		P _O = 1 W, R _L = 4 Ω, f = 20 Hz to 20 kHz		0.1%			
kSVR	Supply ripple rejection ratio	f = 1 kHz, CBYPASS = 0.47 μF, R _L = 8 Ω V _{RIPPLE} = 200 mV _{PP}		-53	dB		
SNR	Signal-to-noise rejection ratio	Maximum output at THD+N < 1%, f = 1 kHz, Gain = 10 dB		90	dB		
	Crosstalk (Left-Right; Right-Left)	f = 1 kHz, P _O = 1 W, Gain = 10 dB		-110	dB		
		f = 10 kHz, P _O = 1 W, Gain = 10 dB		-100	dB		
V _n	Noise output voltage	CBYPASS = 0.47 μF, f = 20 Hz to 20 kHz, Gain = 10 dB, No weighting		21	μV _{rms}		
Z _I	Input Impedance	Gain = 21.6 dB		15	20	kΩ	
G	Gain	GAIN0, GAIN1 = 0.8 V		9.4	10	10.6	dB
		GAIN0 = 0.8 V; GAIN1 = 2 V		11.4	12	12.6	
		GAIN0 = 2 V, GAIN1 = 0.8 V		15	15.6	16.2	
		GAIN0, GAIN1 = 2 V		21	21.6	22.2	
	Gain Matching	Channel-to Channel		0.01		dB	
	Start-up time from shutdown	CBYPASS = 0.47 μF		25		ms	

HEADPHONE AMPLIFIER DC ELECTRICAL CHARACTERISTICS

$T_A = 25^\circ\text{C}$, $HPVDD = CPVDD = VDD = 5\text{ V}$, $R_L = 16\ \Omega$ (unless otherwise noted)

PARAMETER		TEST CONDITIONS	MIN	TYP	MAX	UNIT
$ V_{OS} $	Output offset voltage	Inputs grounded		1	3	mV
PSRR	Power supply rejection ratio	$HPVDD = 4.5\text{ V to }5.5\text{ V}$	-75	-100		dB

HEADPHONE AMPLIFIER AC CHARACTERISTICS

$T_A = 25^\circ\text{C}$, $HPVDD = 5\text{ V}$, $R_L = 16\ \Omega$ (unless otherwise noted)

PARAMETER		TEST CONDITIONS	MIN	TYP	MAX	UNIT
P_O	Output power (outputs in phase)	THD+N = 10%, $R_L = 16\ \Omega$, $f = 1\text{ kHz}$		200		mW
		THD+N = 10%, $R_L = 32\ \Omega$, $f = 1\text{ kHz}$		100		
THD+N	Total harmonic distortion plus noise	$P_O = 85\text{ mW}$, $f = 20\text{ Hz to }20\text{ kHz}$, $R_L = 16\ \Omega$		0.03%		
		$P_O = 50\text{ mW}$, $f = 20\text{ Hz to }20\text{ kHz}$, $R_L = 32\ \Omega$		0.04%		
	Dynamic Range with Signal Present	A-Weighted, $f = 20\text{ Hz to }20\text{ kHz}$		-100		dB FS
kSVR	Supply ripple rejection	$f = 1\text{ kHz}$, 200-mV _{PP} ripple		-60		dB
	Crosstalk	$P_O = 35\text{ mW}$, $f = 20\text{ Hz to }20\text{ kHz}$		-80		dB
SNR	Signal-to-noise ratio	Maximum output at THD+N 1%, $f = 1\text{ kHz}$		95		dB
V_n	Noise output voltage	$f = 20\text{ Hz to }20\text{ kHz}$, No weighting		20		μV_{rms}
Z_I	Input Impedance		15	20		k Ω
Gain	Closed-loop voltage gain	$R_L = 16\ \Omega$	-1.45	-1.5	-1.55	V/V
	Start-up time from shutdown			5		ms

LDO CHARACTERISTICS

$T_A = 25^\circ\text{C}$, $VDD = 5\text{ V}$ (unless otherwise noted)

PARAMETER		TEST CONDITIONS	MIN	TYP	MAX	UNIT
V_I	Input voltage	V_{DD}	4.5		5.5	V
I_O	Continuous output current		120			mA
V_O	Output voltage	$0 < I_O < 120\text{ mA}$; $4.9\text{ V} < V_{in} < 5.5\text{ V}$	3.2	3.3	3.4	V
	Line regulation	$I_L = 5\text{ mA}$; $4.9\text{ V} < V_{in} < 5.5\text{ V}$		1.8	10	mV
	Load regulation	$I_L = 0 - 120\text{ mA}$, $V_{in} = 5\text{ V}$		0.13	0.23	mV/ mA
	Power supply ripple rejection	$V_{DD} = 4.9\text{ V}$, $I_L = 10\text{ mA}$		-46		dB
		$f = 100\text{ Hz}$				

TYPICAL CHARACTERISTICS

Default graph conditions: $V_{CC} = 5\text{ V}$, $\text{Freq} = 1\text{ kHz}$, AES17 Filter.

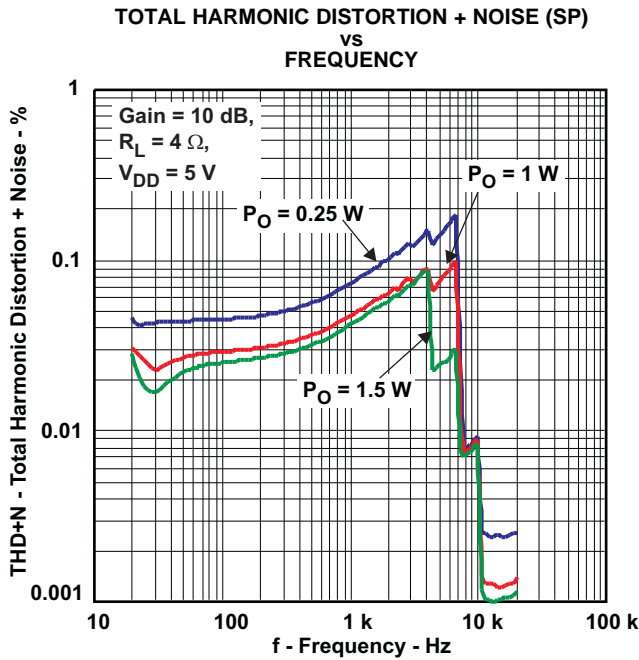

Figure 1.

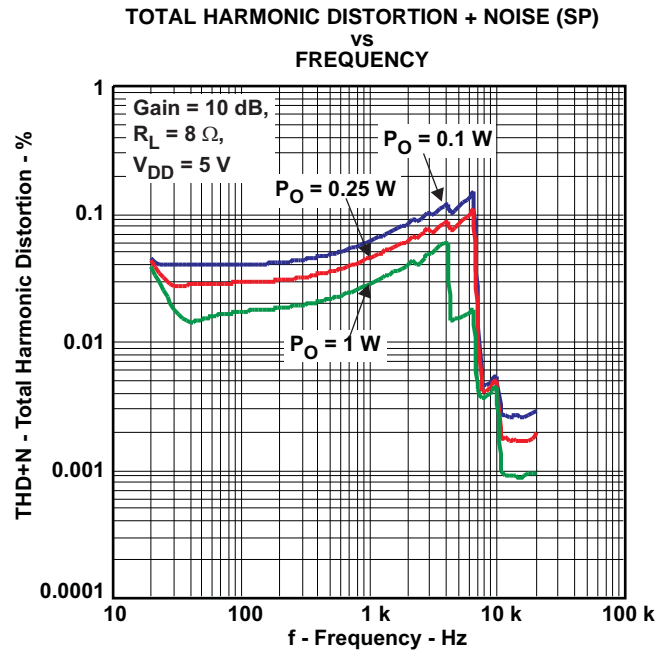

Figure 2.

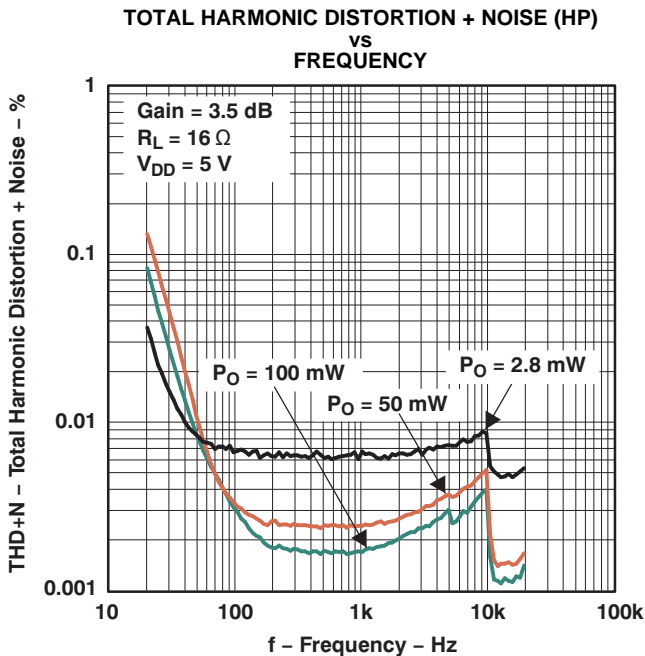

Figure 3.

G003

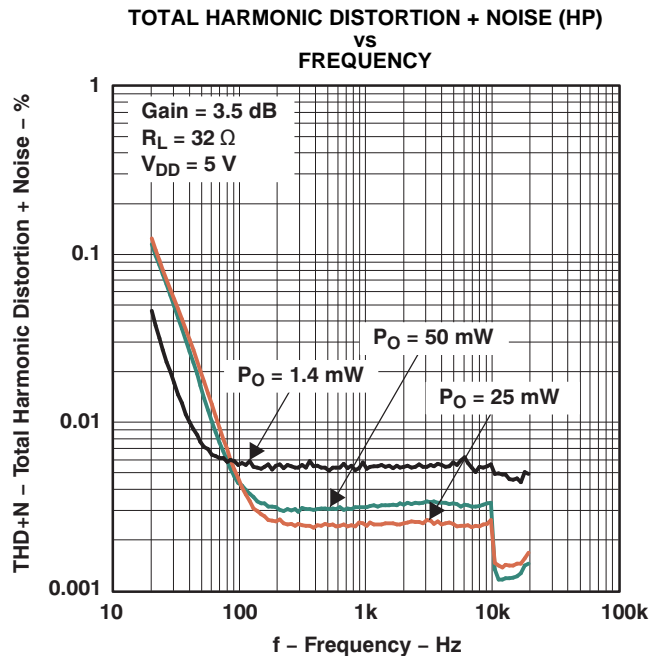

Figure 4.

G004

TYPICAL CHARACTERISTICS (continued)

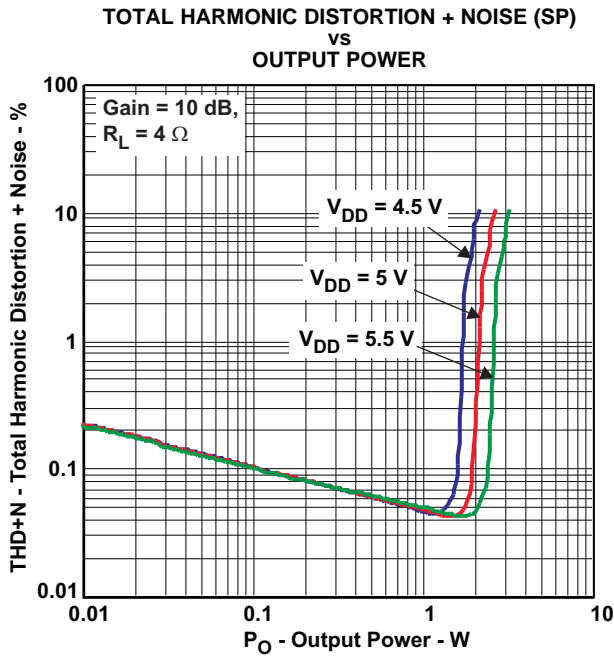

Figure 5.

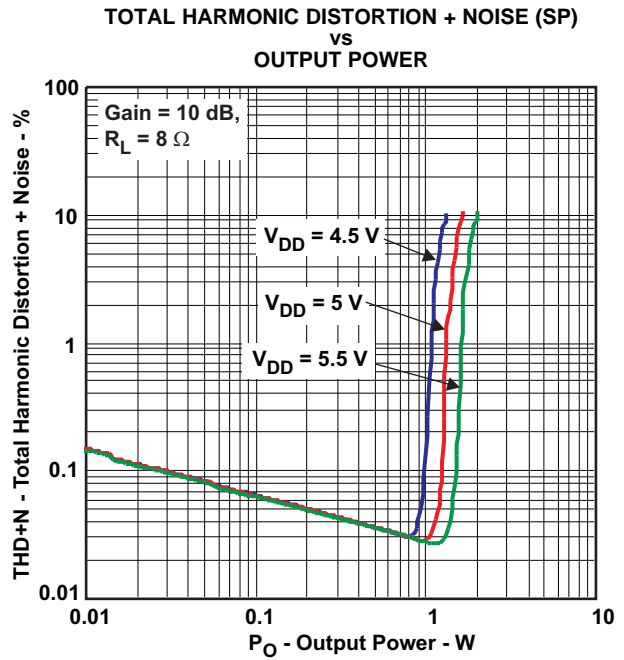

Figure 6.

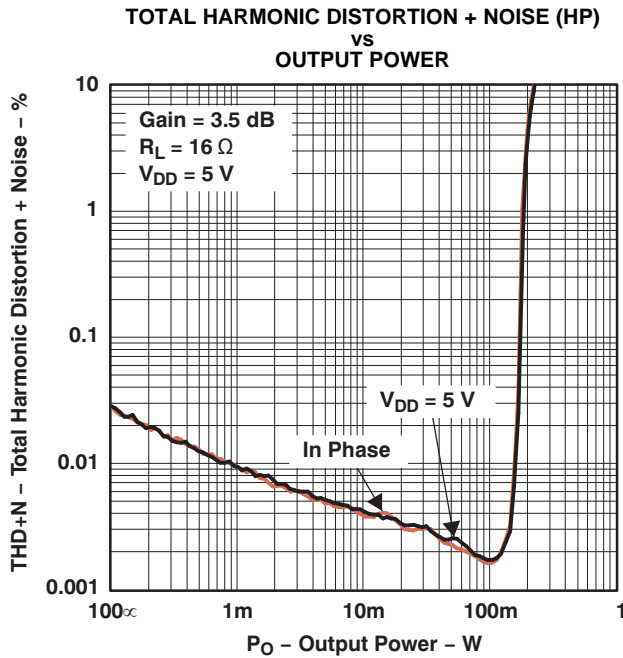

Figure 7.

G007

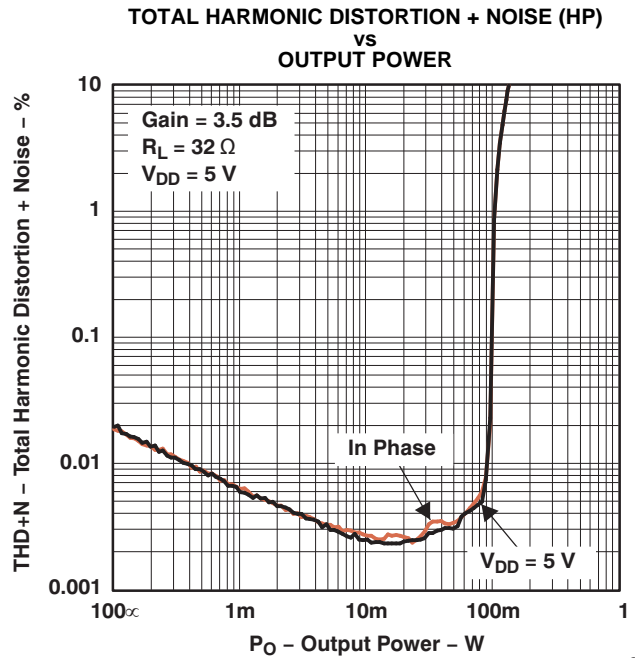

Figure 8.

G008

TYPICAL CHARACTERISTICS (continued)

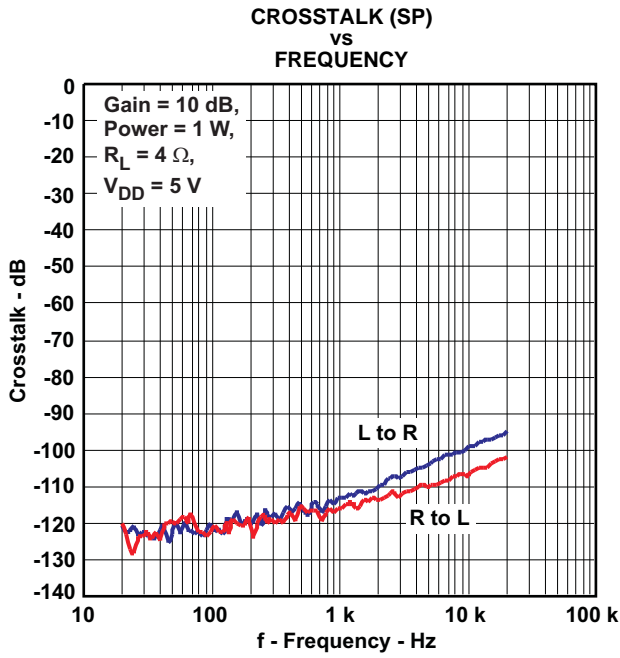

Figure 9.

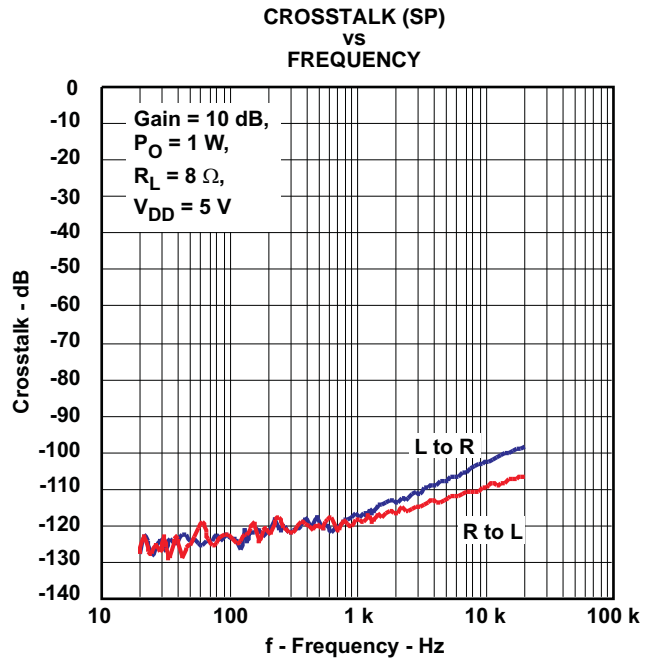

Figure 10.

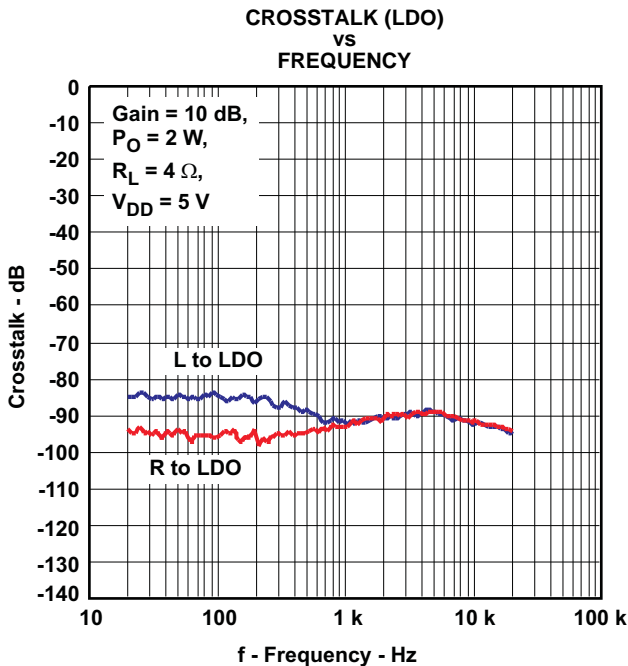

Figure 11.

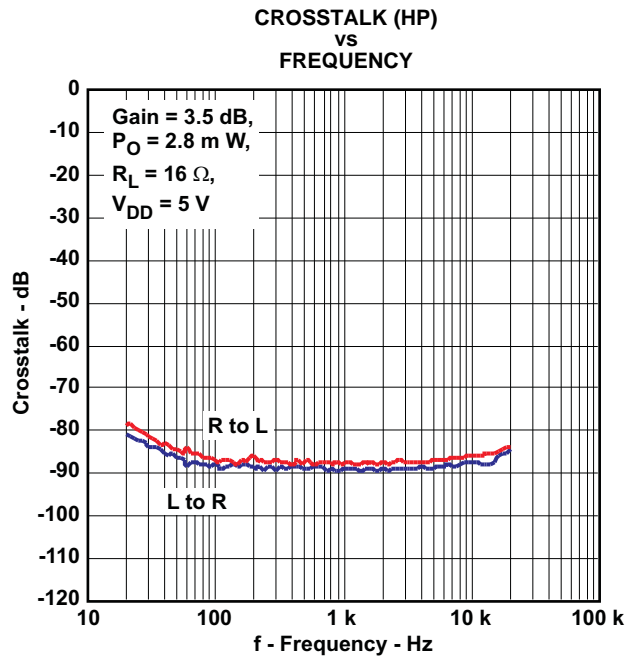

Figure 12.

TYPICAL CHARACTERISTICS (continued)

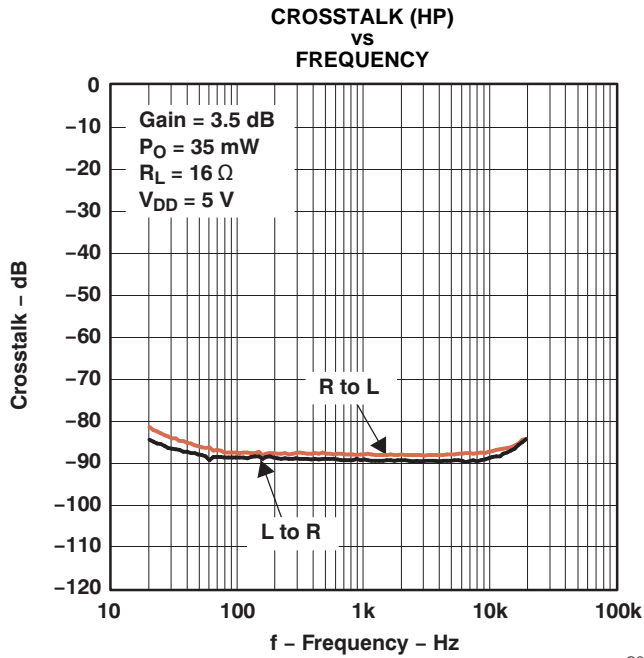

Figure 13.

G012

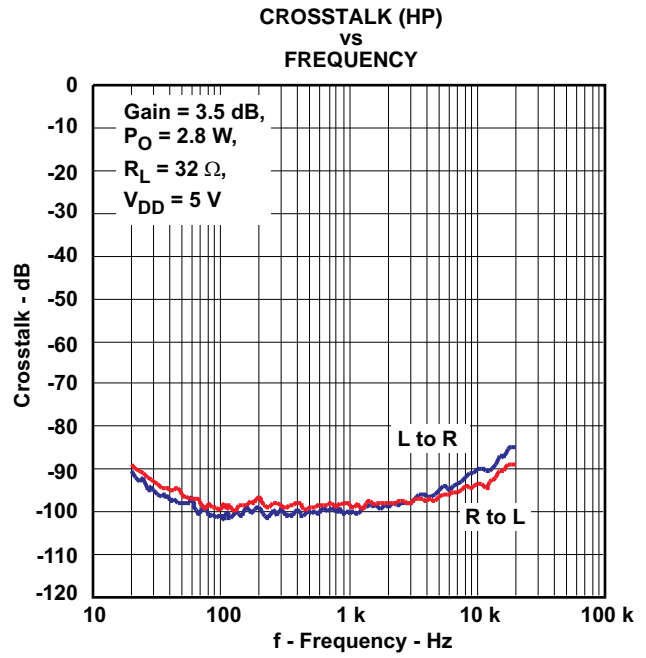

Figure 14.

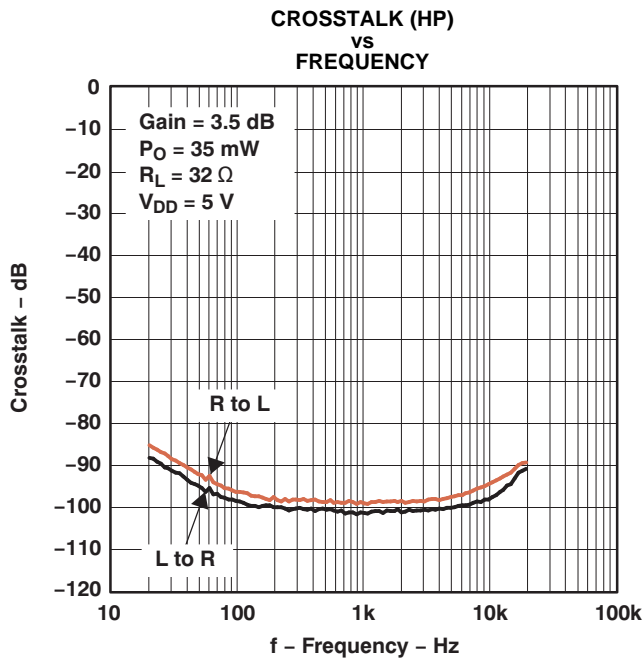

Figure 15.

G013

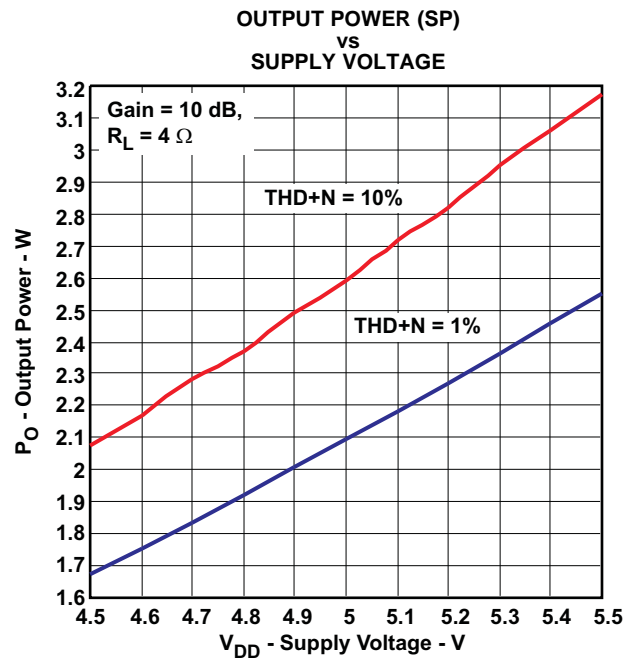

Figure 16.

TYPICAL CHARACTERISTICS (continued)

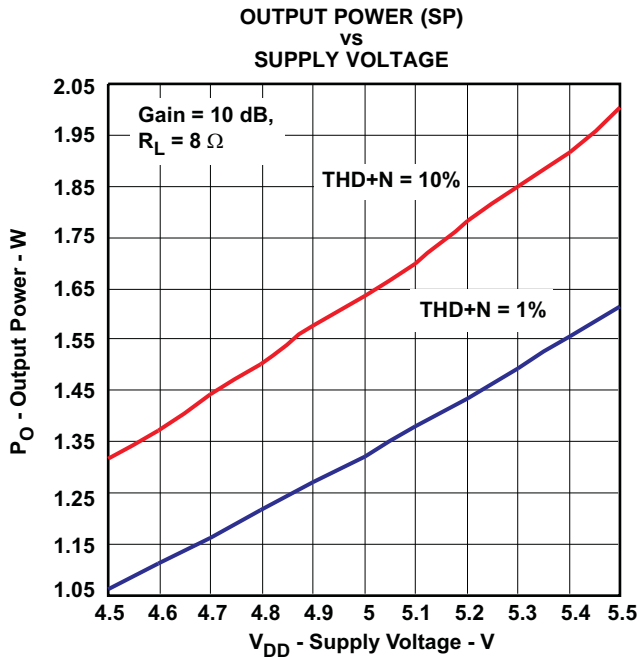

Figure 17.

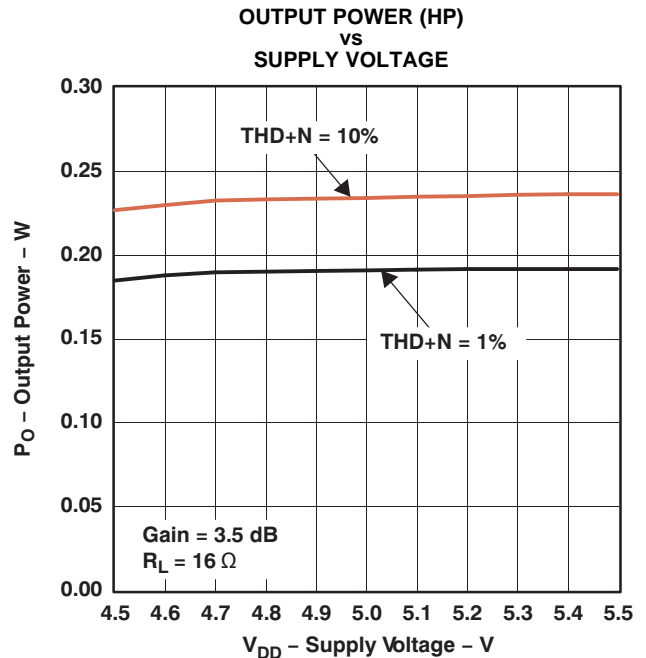

Figure 18.

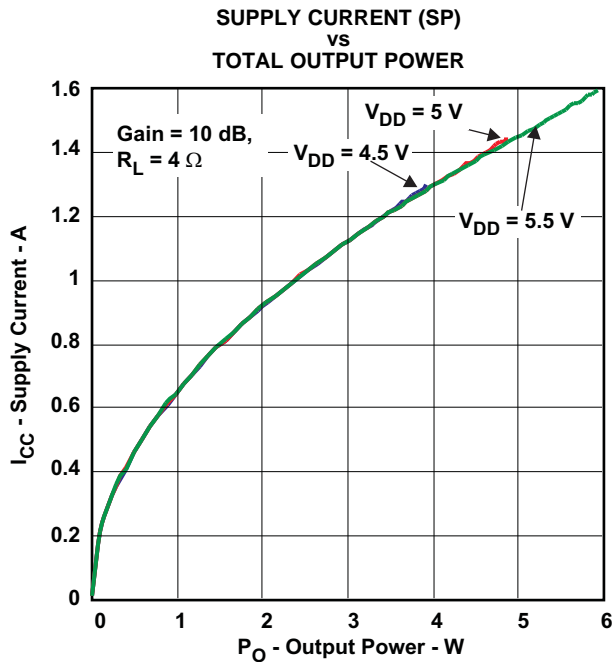

Figure 19.

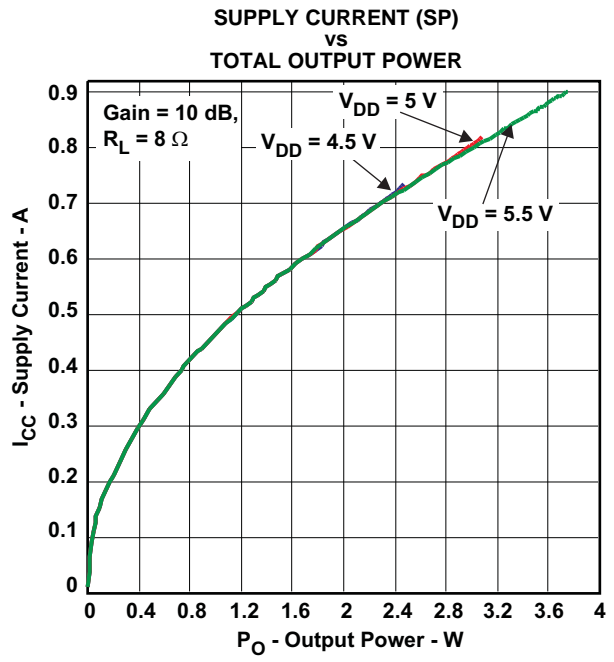

Figure 20.

TYPICAL CHARACTERISTICS (continued)

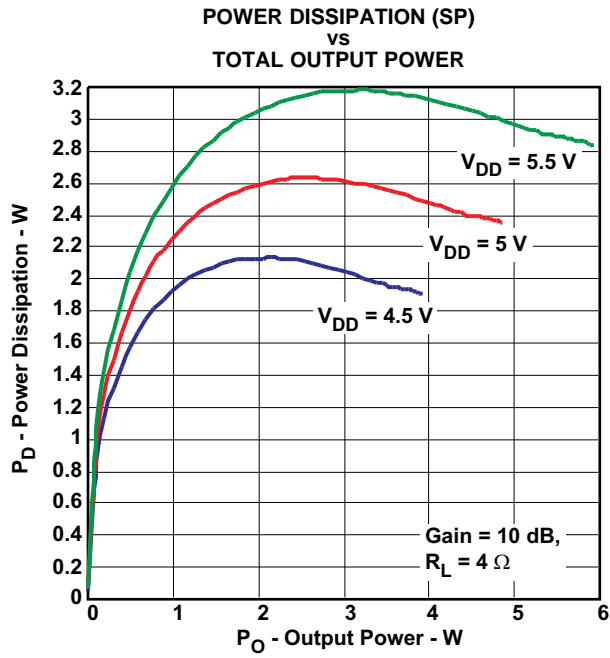

Figure 21.

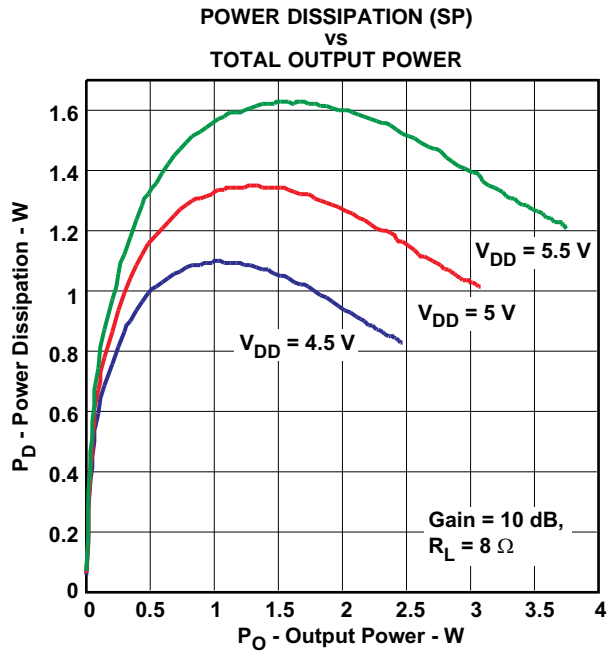

Figure 22.

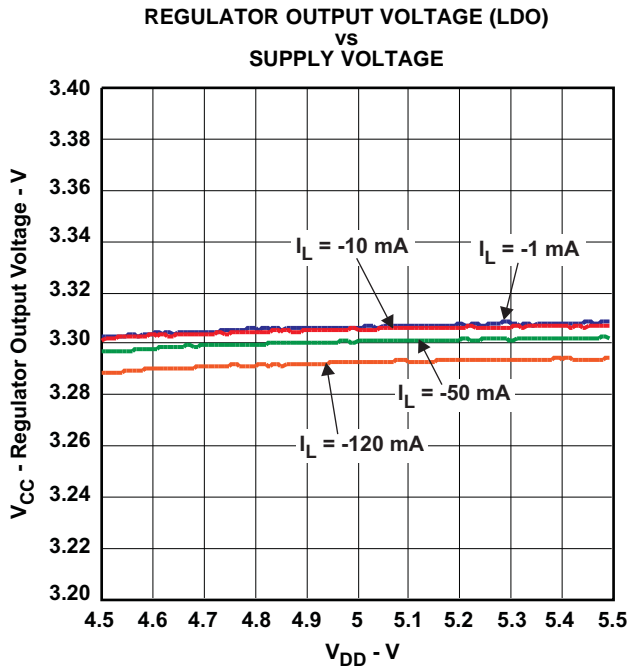

Figure 23.

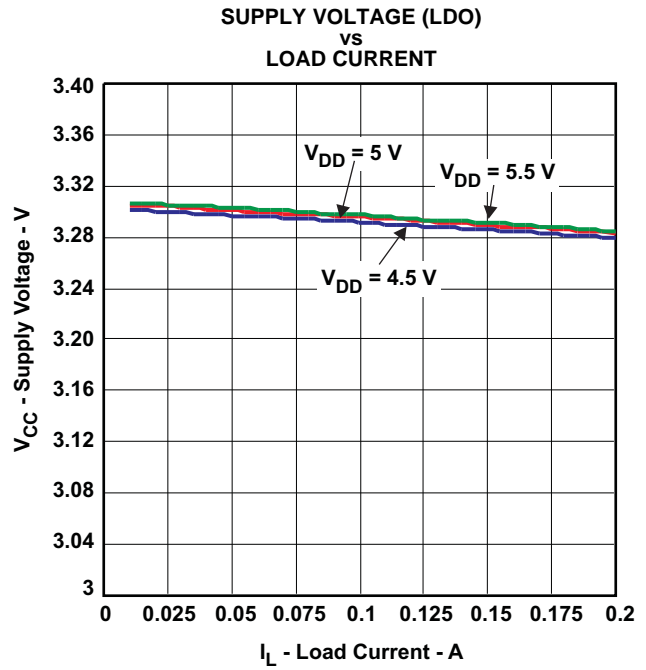

Figure 24.

TYPICAL CHARACTERISTICS (continued)

**COMMON-MODE REJECTION RATIO (SP)
vs
FREQUENCY**

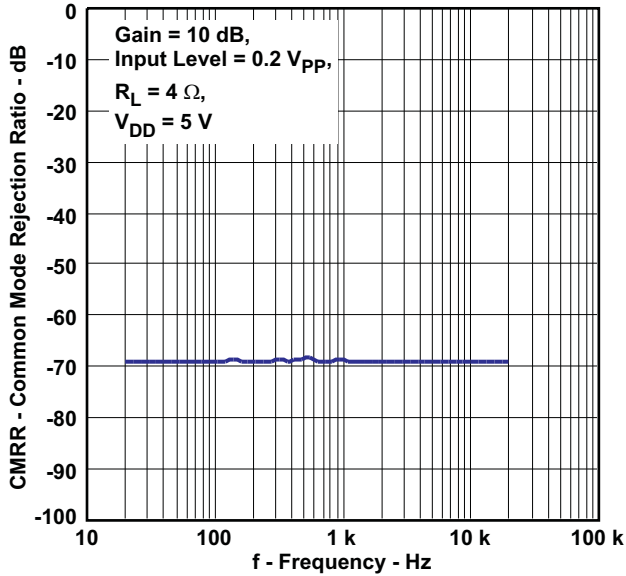

Figure 25.

**COMMON-MODE REJECTION RATIO (SP)
vs
FREQUENCY**

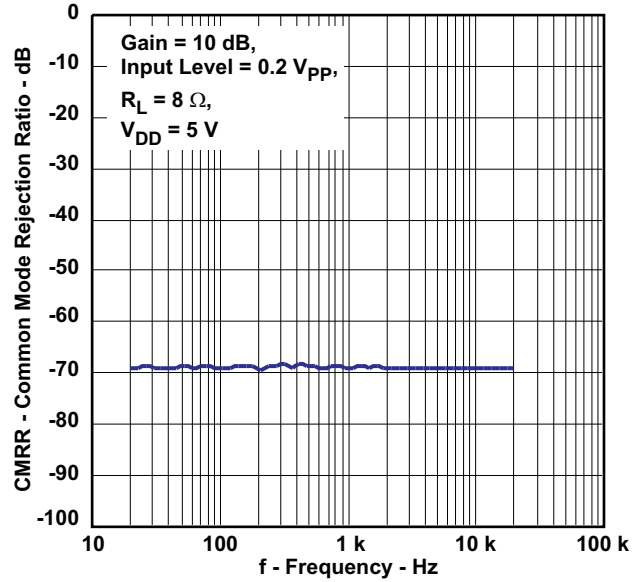

Figure 26.

**POWER SUPPLY REJECTION RATIO (LDO)
vs
FREQUENCY**

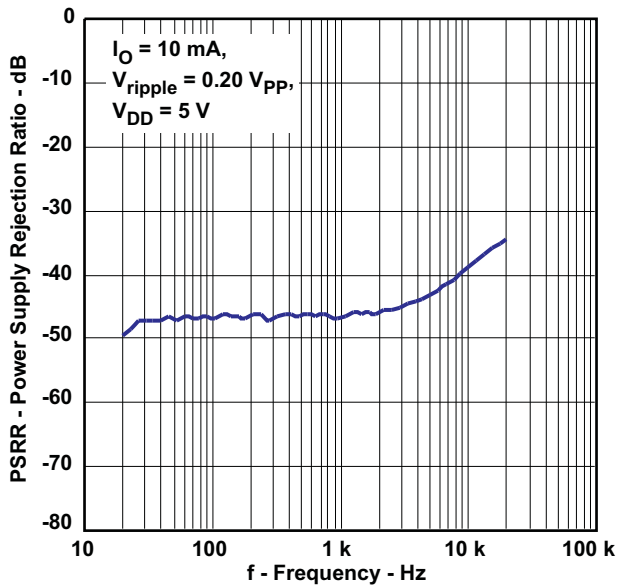

Figure 27.

**POWER SUPPLY REJECTION RATIO (SP)
vs
FREQUENCY**

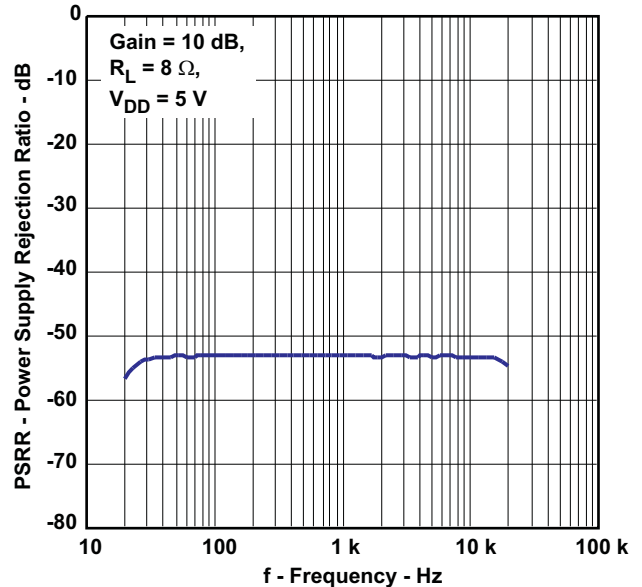

Figure 28.

TYPICAL CHARACTERISTICS (continued)

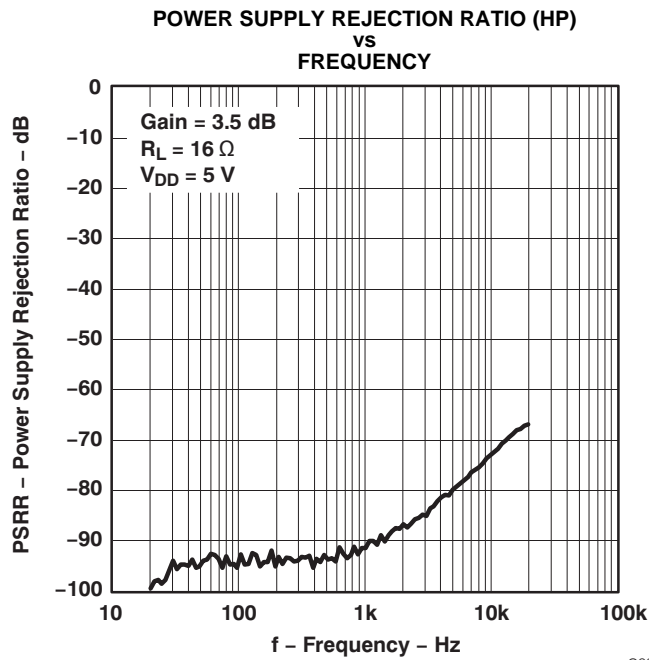

Figure 29.

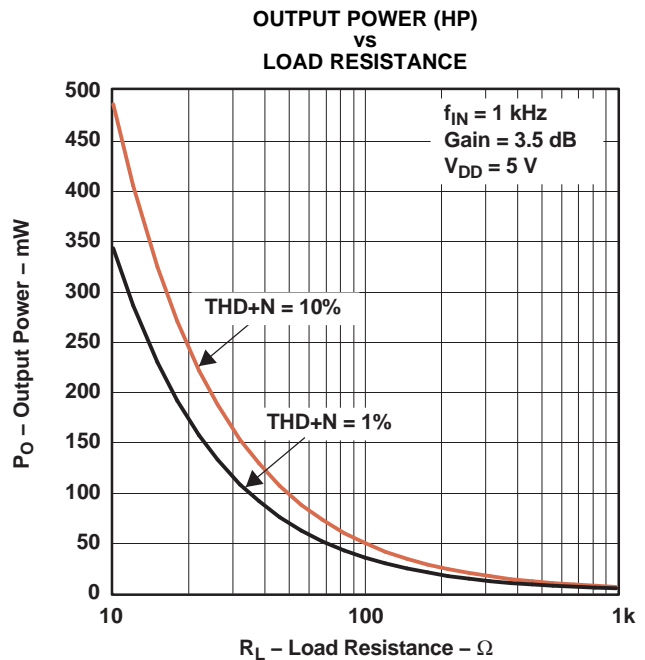

Figure 30.

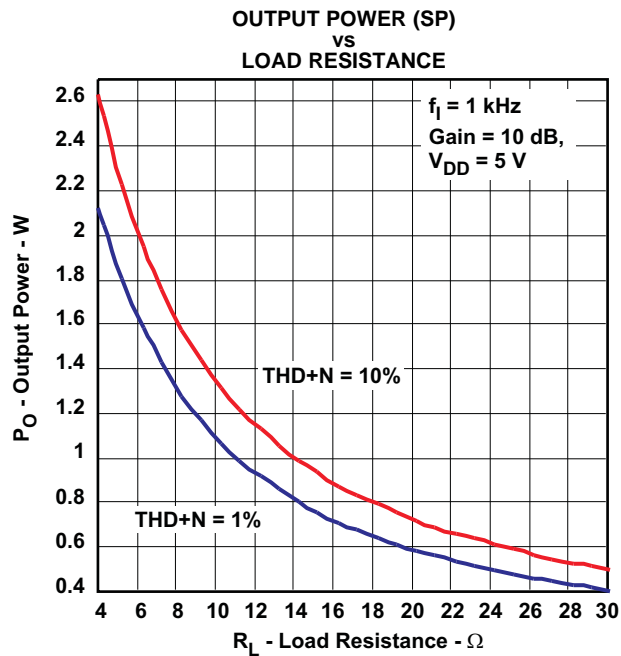

Figure 31.

TYPICAL CHARACTERISTICS (continued)

SPEAKER SHUTDOWN - 8 Ω - 10 dB

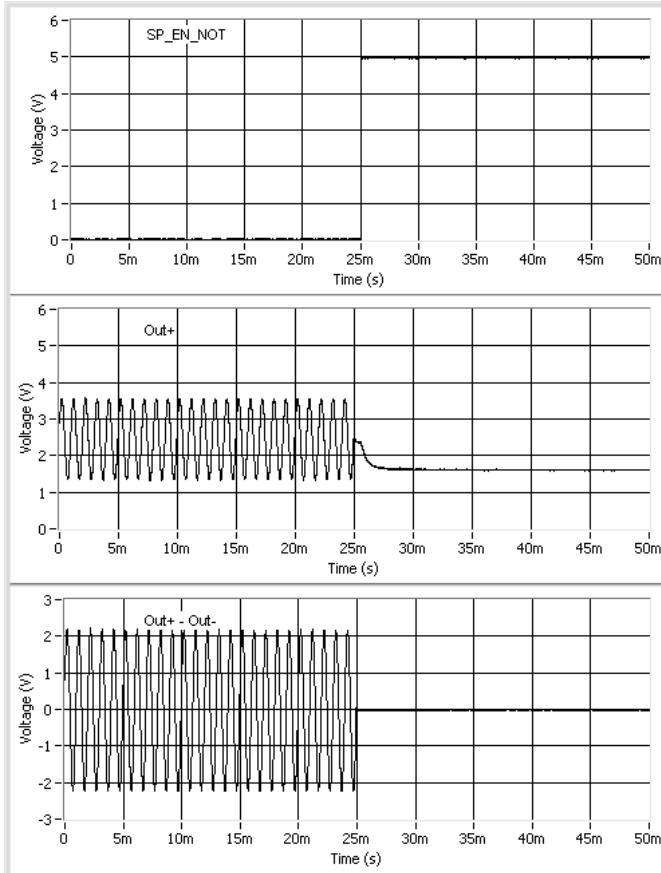

Figure 32.

SPEAKER STARTUP - 8 Ω - 10 dB

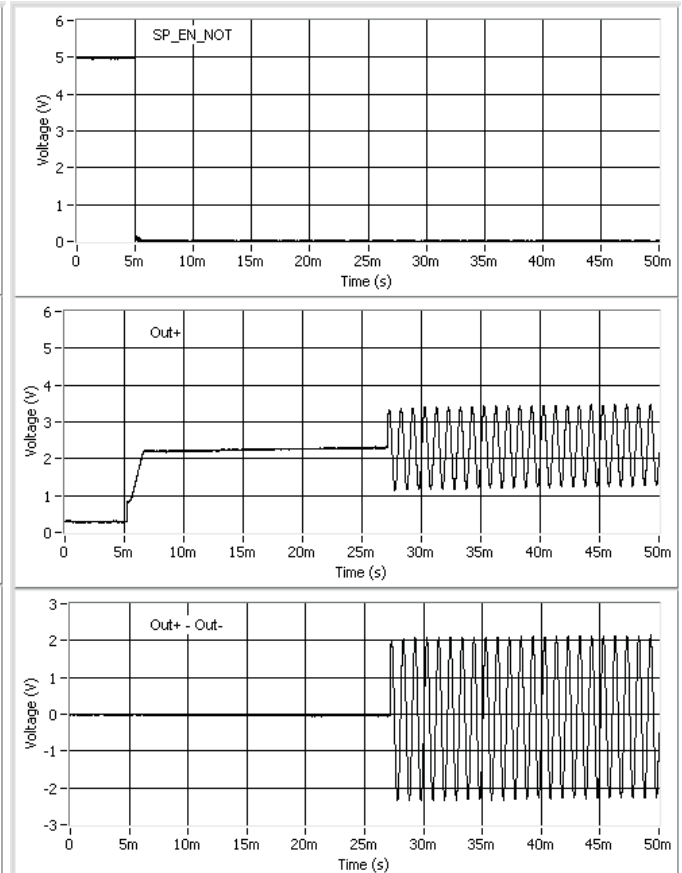

Figure 33.

LDO SHUTDOWN - 120 mA

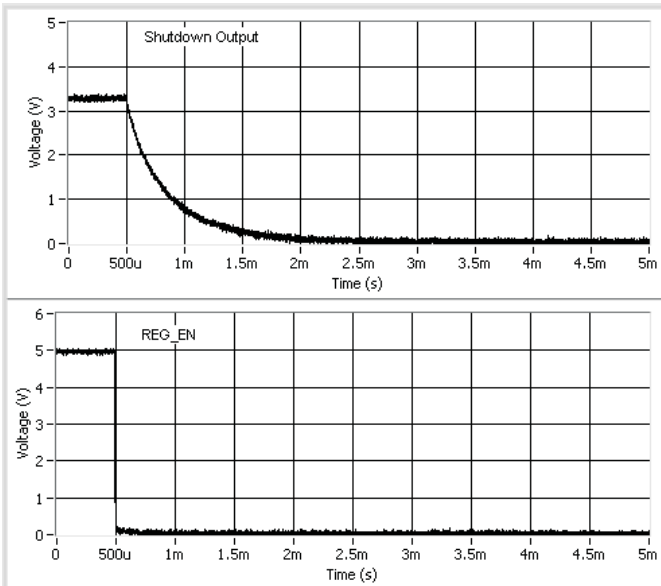

Figure 34.

LDO STARTUP - 120 mA

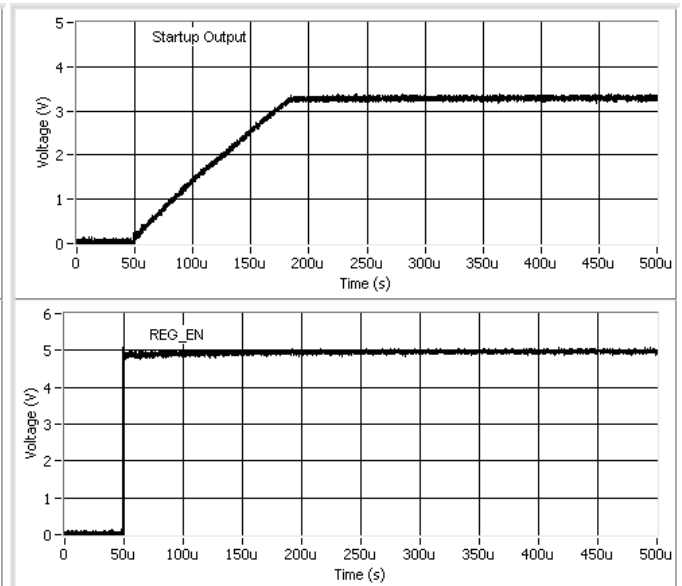

Figure 35.

TYPICAL CHARACTERISTICS (continued)

HP SHUTDOWN - 32 Ω

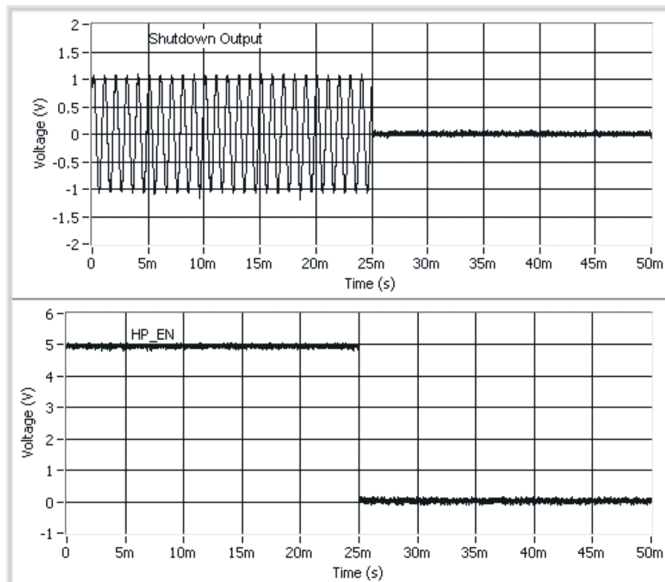

Figure 36.

HP STARTUP - 32 Ω

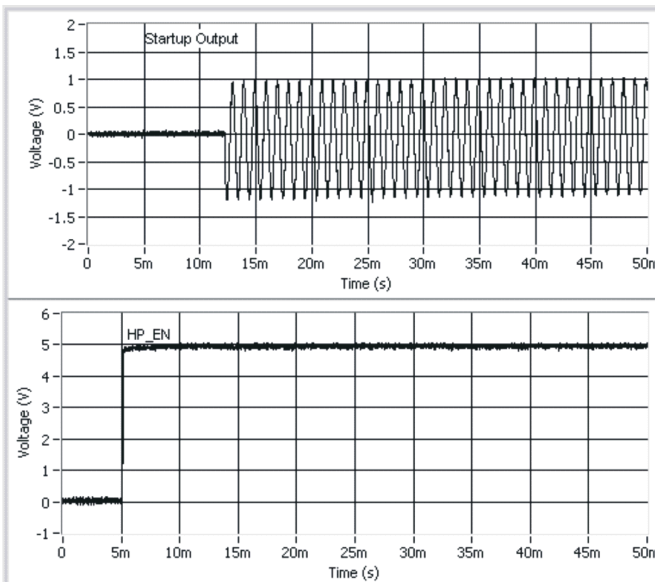

Figure 37.

APPLICATION INFORMATION

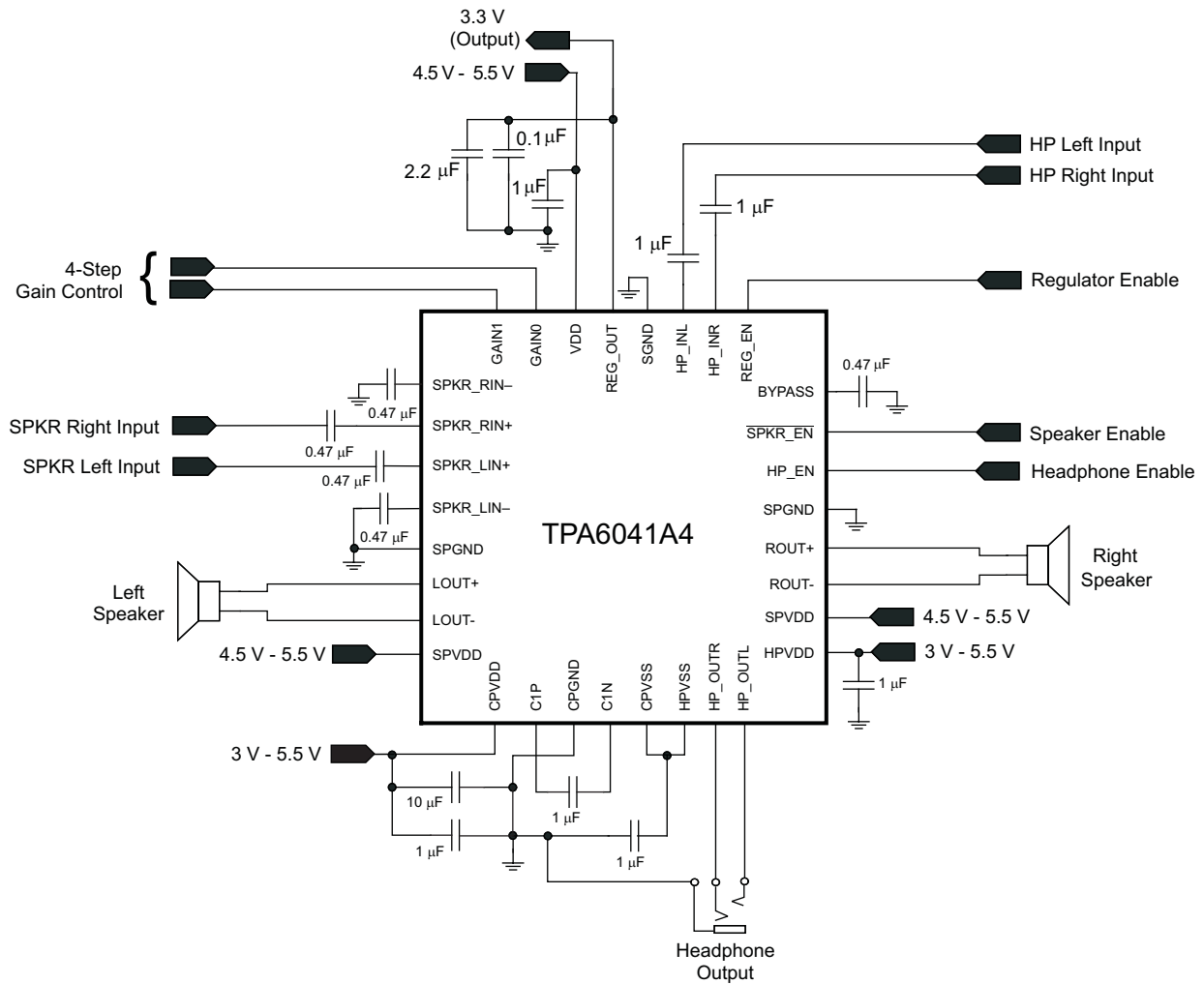

Figure 38. Single-Ended Input Application Circuit

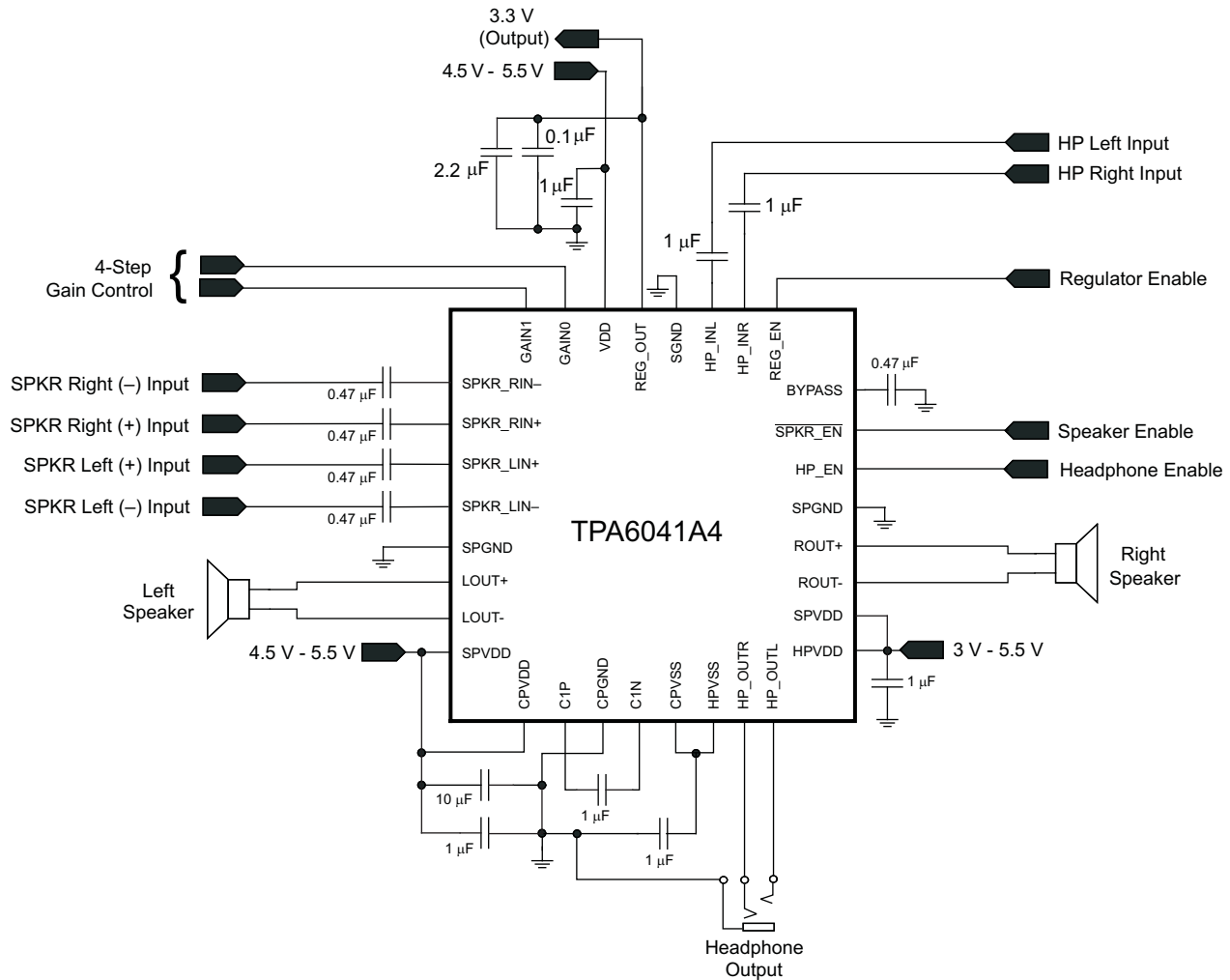

Figure 39. Differential Input Application Circuit

Power Enable Modes

The TPA6041A4 allows disable of any or all of the main circuit blocks when not in use in order to reduce operating power to an absolute minimum. The $\overline{\text{SPKR_EN}}$ control can be used to disable the speaker amplifier while the $\overline{\text{HP_EN}}$ can be used separately to turn off the headphone amplifier. The LDO also has an independent power control, $\overline{\text{REG_EN}}$. With all circuit blocks disabled, the supply current in shutdown mode is only 5 μA . See the General DC Electrical Characteristics for operating currents with each circuit block operating independently.

Speaker Amplifier Description

The speaker amplifier is capable of driving 2.1 W/ch of continuous RMS power into a 4- Ω load at 5 V. An internal 4-step control allows variation of the gain from 10 dB to 21.6 dB.

Fully Differential Amplifier

The TPA6041A4 speaker amplifier is a fully differential amplifier with differential inputs and outputs. The fully differential architecture consist of a differential amplifier and a common mode amplifier. The differential amplifier ensures that the amplifier outputs a differential voltage that is equal to the differential input times the gain. The common-mode voltage at the output is biased around $V_{\text{DD}}/2$ regardless of the common-mode voltage at the input.

One of the primary advantages of the fully differential amplifier is improved RF immunity. GSM handsets save power by turning on and off the RF transmitter at a rate of 217 Hz. The transmitted signal is picked up on input and output traces. The fully differential amplifier cancels the signal and others of this type much better than typical audio amplifiers.

Gain Setting via GAIN0 and GAIN1 Inputs

The gain of the TPA6041A4 is set by two terminals, GAIN0 and GAIN1. The gains listed in Table 1 are realized by changing the taps on the input resistors and feedback resistors inside the amplifier. This causes the input impedance (Z_i) to vary as a function of the gain setting.

Gain Setting

GAIN1	GAIN0	AMPLIFIER GAIN (dB)	INPUT IMPEDANCE (k Ω)
		TYPICAL	TYPICAL
0	0	10	78
0	1	12	65
1	0	15.6	46
1	1	21.6	20

Input Capacitor, C_i

The input capacitor allows the amplifier to bias the input signal to the proper dc level for proper operation. In this case, the input capacitor, C_i , and the input impedance of the amplifier, R_i , form a high-pass filter with the corner frequency determined in Equation 1. Figure 40 shows how the input capacitor and the input resistor within the amplifier interact.

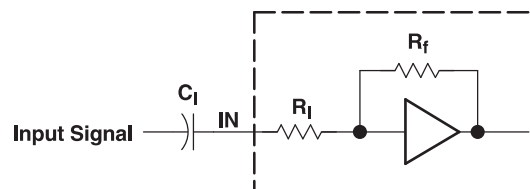
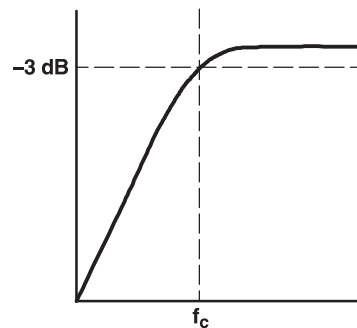

Figure 40. Input Resistor and Input Capacitor

$$f_{c(\text{highpass})} = \frac{1}{2\pi R_i C_i} \quad (1)$$



(1)

The value of C_i is important to consider as it directly affects the low-frequency, or bass, performance of the circuit. Furthermore, the input impedance changes with a change in volume. The higher the volume, the lower the input impedance is. To determine the appropriate capacitor value, reconfigure Equation 1 into Equation 2. The value of the input resistor, R_i , can be determined from Equation 2.

$$C_i = \frac{1}{2\pi R_i f_c} \quad (2)$$

Low-leakage tantalum or ceramic capacitors are recommended. When polarized capacitors are used, the positive side of the capacitor should face the amplifier input in most applications as the dc level there is held at $V_{CC}/2$, which is likely higher than the source dc level. Note that it is important to confirm the capacitor polarity in each specific application. Recommended capacitor values are between 0.1 μF and 1 μF .

Windows Vista™ Premium Mobile Mode Specifications

Device Type	Requirement	Windows Premium Mobile Vista Specifications	TPA6041A4 Typical Performance
Analog Speaker Line Jack ($R_L = 10\text{ k}\Omega$, $FS = 0.707\text{ V}_{rms}$)	THD+N	$\leq -65\text{ dB FS [20 Hz, 20 kHz]}$	$-88\text{ dB FS [20 Hz, 20 kHz]}$
	Dynamic Range with Signal Present	$\leq -80\text{ dB FS A-Weight}$	$-88\text{ dB FS A-Weight}$
	Line Output Crosstalk	$\leq -60\text{ dB [20 Hz, 20 kHz]}$	$-105\text{ dB [20 Hz, 20 kHz]}$
Analog Headphone Out Jack ($R_L = 32\Omega$, $FS = 0.300\text{ V}_{rms}$)	THD+N	$\leq -45\text{ dB FS [20 Hz, 20 kHz]}$	$-88\text{ dB FS [20 Hz, 20 kHz]}$
	Dynamic Range with Signal Present	$\leq -80\text{ dB FS A-Weight}$	$-89\text{ dB FS A-Weight}$
	Headphone Output Crosstalk	$\leq -60\text{ dB [20 Hz, 20 kHz]}$	$-100\text{ dB [20 Hz, 20 kHz]}$

Bridge-Tied Load Versus Single-Ended Mode

Figure 41 shows a Class-AB audio power amplifier (APA) in a bridge-tied-load (BTL) configuration. The TPA6041A4 speaker amplifier consists of two Class-AB differential amplifiers per channel driving the positive and negative terminals of the load. Specifically, differential drive means that as one side of the amplifier (the positive terminal, for example) is slewing up, the other side is slewing down, and vice versa. This doubles the voltage swing across the load as opposed to a ground-referenced load, or a single-ended load. Power is proportional to the square of the voltage. Plugging $2x\text{ VO(PP)}$ into the power equation yields $4x$ the output power from the same supply rail and load impedance as would have been obtained with a ground-referenced load (see Equation 3).

$$V_{(RMS)} = \frac{V_{O(PP)}}{2\sqrt{2}}$$

$$\text{Power} = \frac{V_{(RMS)}^2}{R_L}$$

(3)

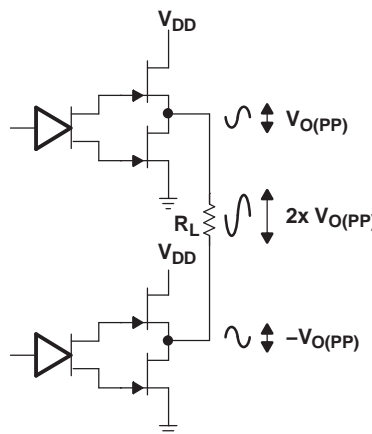

Figure 41. Differential Output Configuration

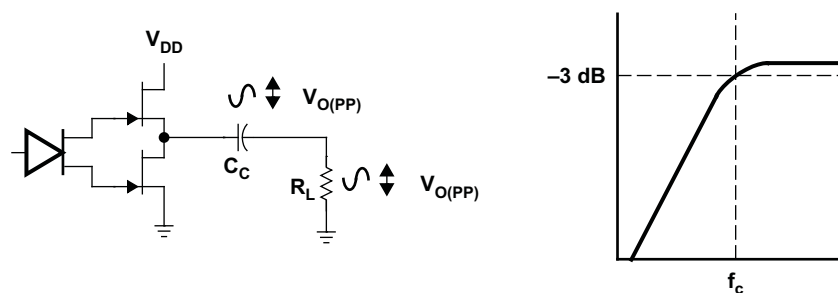

Figure 42. Single-Ended Configuration and Frequency Response

Bridge-tying the outputs in a typical computer audio, LCD TV, or multimedia LCD monitor application drastically increases output power. For example, if an amplifier in a single-ended configuration was capable of outputting a maximum of 250 mW for a given load with a supply voltage of 12 V, then that same amplifier would be able to output 1 W of power in a BTL configuration with the same supply voltage and load. In addition to the increase in output power, the BTL configuration does not suffer from the same low-frequency issues that plague the single-ended configuration. In a BTL configuration, there is no need for an output capacitor to block dc, so no unwanted filtering occurs. In addition, the BTL configuration saves money and space, as the dc-blocking capacitors needed for single-ended operation are large and expensive. For example, with an 8-Ω load in SE operation, the user needs a 1000-μF capacitor to obtain a cutoff frequency below 20 Hz. This capacitor is expensive and large.

Headphone Amplifier Description

The headphone amplifier has a fixed gain of -1.5 V/V. It uses single-ended (SE) inputs. The DirectPath™ amplifier architecture operates from a single supply but makes use of an internal charge pump to provide a negative voltage rail. Combining the user-provided positive rail and the negative rail generated by the IC, the device operates in what is effectively a split supply mode. The output voltages are now centered at zero volts with the capability to swing to the positive rail or negative rail. The DirectPath™ amplifier requires no output dc blocking capacitors and does not place any voltage on the sleeve. The block diagram and waveform of [Figure 43](#) illustrate the ground-referenced headphone architecture. This is the architecture of the TPA6041A4.

Single-supply headphone amplifiers typically require dc-blocking capacitors. The capacitors are required because most headphone amplifiers have a dc bias on the outputs pin. If the dc bias is not removed, the output signal is severely clipped, and large amounts of dc current rush through the headphones, potentially damaging them. The left-side drawing in [Figure 43](#) illustrates the conventional headphone amplifier connection to the headphone jack and output signal.

DC blocking capacitors are often large in value. The headphone speakers (typical resistive values of 16 Ω or 32 Ω) combine with the dc blocking capacitors to form a high-pass filter. [Equation 4](#) shows the relationship between the load impedance (R_L), the capacitor (C_O), and the cutoff frequency (f_c).

$$f_c = \frac{1}{2\pi R_L C_O} \quad (4)$$

C_O can be determined using [Equation 5](#), where the load impedance and the cutoff frequency are known.

$$C_O = \frac{1}{2\pi R_L f_c} \quad (5)$$

If f_c is low, the capacitor must then have a large value because the load resistance is small. Large capacitance values require large package sizes. Large package sizes consume PCB area, stand high above the PCB, increase cost of assembly, and can reduce the fidelity of the audio output signal.

Two different headphone amplifier applications are available that allow for the removal of the output dc blocking capacitors. The capacitor-less amplifier architecture is implemented in the same manner as the conventional amplifier with the exception of the headphone jack shield pin. This amplifier provides a reference voltage, which is connected to the headphone jack shield pin. This is the voltage on which the audio output signals are centered. This voltage reference is half of the amplifier power supply to allow symmetrical swing of the output voltages. Do not connect the shield to any GND reference, or large currents will result. The scenario can happen if, for example, an accessory other than a floating GND headphone is plugged into the headphone connector. See the second block diagram and waveform in [Figure 43](#).

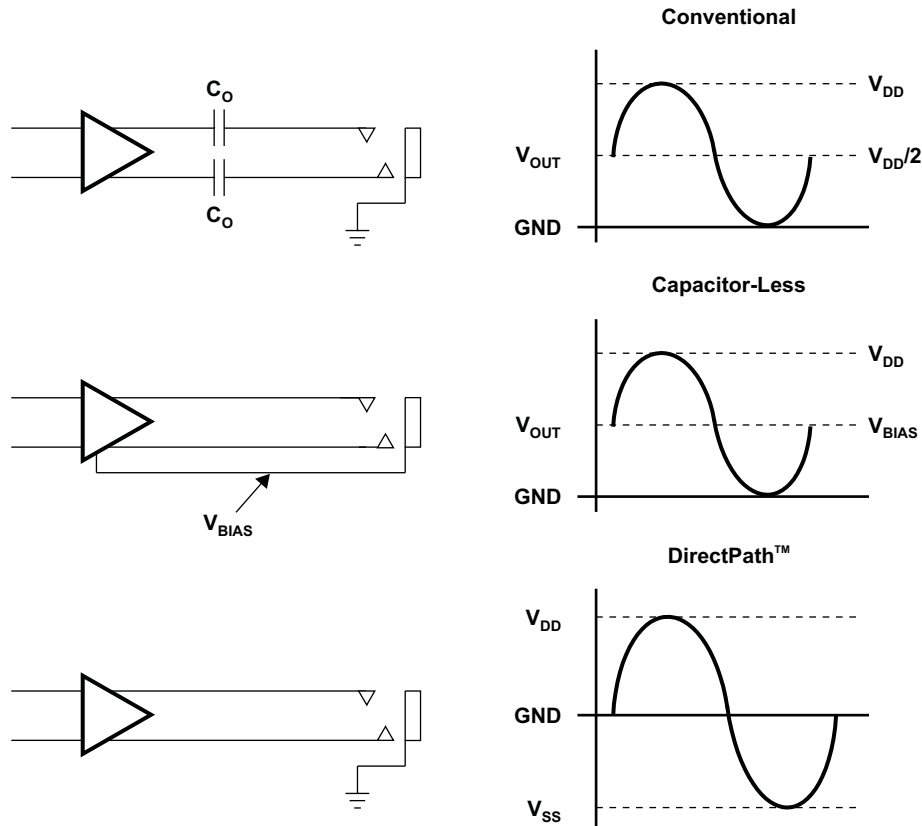

Figure 43. Amplifier Applications

Input-Blocking Capacitors

DC input-blocking capacitors block the dc portion of the audio source and allow the inputs to properly bias. Maximum performance is achieved when the inputs of the TPA6041A4 are properly biased. Performance issues such as pop are optimized with proper input capacitors.

The dc input-blocking capacitors can be removed, provided the inputs are connected differentially and within the input common-mode range of the amplifier, the audio signal does not exceed ± 3 V, and pop performance is sufficient.

C_{IN} is a theoretical capacitor used for mathematical calculations only. Its value is the series combination of the dc input-blocking capacitors, $C_{(DCINPUT-BLOCKING)}$. Use Equation 6 to determine the value of $C_{(DCINPUT-BLOCKING)}$. For example, if C_{IN} is equal to 0.22 μ F, then $C_{(DCINPUT-BLOCKING)}$ is equal to about 0.47 μ F.

$$C_{IN} = \frac{1}{2} C_{(DCINPUT-BLOCKING)} \tag{6}$$

The two $C_{(DCINPUT-BLOCKING)}$ capacitors form a high-pass filter with the input impedance of the TPA6041A4. Use Equation 6 to calculate C_{IN} , then calculate the cutoff frequency using C_{IN} and the differential input impedance of the TPA6041A4, R_{IN} , using Equation 7. Note that the differential input impedance changes with gain. See Figure 39 for input impedance values. The frequency and/or capacitance can be determined when one of the two values are given.

$$f_{C_{IN}} = \frac{1}{2\pi R_{IN} C_{IN}} \quad \text{or} \quad C_{IN} = \frac{1}{2\pi f_{C_{IN}} R_{IN}} \quad (7)$$

If a high-pass filter with a -3-dB point of no more than 20 Hz is desired over all gain settings, the minimum impedance would be used in the Equation 7. The minimum input impedance for TPA6041A4 is 20 kΩ. The capacitor value by Equation 7 would be 0.399 μF. However, this is C_{IN} , and the desired value is for $C_{(DCINPUT-BLOCKING)}$. Multiplying C_{IN} by 2 yields 0.80 μF, which is close to the standard capacitor value of 1 μF. Place 1-μF capacitors at each input terminal of the TPA6041A4 to complete the filter.

Charge Pump Flying Capacitor and CPVSS Capacitor

The charge pump flying capacitor serves to transfer charge during the generation of the negative supply voltage. The CPVSS capacitor must be at least equal to the flying capacitor in order to allow maximum charge transfer. Low ESR capacitors are an ideal selection, and a value of 1 μF is typical.

Decoupling Capacitors

The TPA6041A4 is a DirectPath™ headphone amplifier that requires adequate power supply decoupling to ensure that the noise and total harmonic distortion (THD) are as low as possible. To filter high-frequency transients, spikes, and digital hash on the power line, use good low equivalent-series-resistance (ESR) ceramic capacitors, typically 1 μF. Find the smallest package possible, and place as close as possible to the device V_{DD} lead. Placing the decoupling capacitors close to the TPA6041A4 is important for the performance of the amplifier. Use a 10 μF or greater capacitor near the TPA6041A4 to filter lower frequency noise signals; however, the high PSRR of the TPA6041A4 makes the 10-μF capacitor unnecessary in most applications.

Midrail Bypass Capacitor, C_{BYPASS}

The midrail bypass capacitor, $C_{(BYPASS)}$, has several important functions. During start-up or recovery from shutdown mode, C_{BYPASS} determines the rate at which the amplifier starts up. A 1-μF capacitor yields a start-up time of approximately 30 ms. C_{BYPASS} also reduces the noise coupled into the output signal by the power supply. This improves the power supply ripple rejection (PSRR) of the amplifier. Ceramic or polyester capacitors with low ESR and values in the range of 0.47 μF to 1 μF are recommended.

LOW DROPOUT REGULATOR (LDO) DESCRIPTION

The TPA6041A4 contains a 3.3-V output low dropout regulator (LDO) capable of providing a maximum of 120 mA with a drop of less than 150 mV from the 5-V supply. This can be used to power an external CODEC. A 10-μF decoupling capacitor is recommended at the output of the LDO as well as 0.1-μF capacitor to filter high-frequency noise from the supply line.

LAYOUT RECOMMENDATIONS

Solder the exposed thermal pad (metal pad on the bottom of the part) on the TPA6041A4 QFN package to a pad on the PCB.

It is important to keep the TPA6041A4 external components close to the body of the amplifier to limit noise pickup. One should lay out the differential input leads symmetrical and close together to take advantage of the inherent common mode rejection of the TPA6041A4. The layout of the TPA6041A4 evaluation module (EVM) is a good example of component placement and the layout files are available at www.ti.com.

PACKAGING INFORMATION

Orderable Device	Status ⁽¹⁾	Package Type	Package Drawing	Pins	Package Qty	Eco Plan ⁽²⁾	Lead/Ball Finish	MSL Peak Temp ⁽³⁾
TPA6041A4RHBR	ACTIVE	QFN	RHB	32	3000	Green (RoHS & no Sb/Br)	Call TI	Level-3-260C-168 HR
TPA6041A4RHBRG4	ACTIVE	QFN	RHB	32	3000	Green (RoHS & no Sb/Br)	Call TI	Level-3-260C-168 HR

⁽¹⁾ The marketing status values are defined as follows:

ACTIVE: Product device recommended for new designs.

LIFEBUY: TI has announced that the device will be discontinued, and a lifetime-buy period is in effect.

NRND: Not recommended for new designs. Device is in production to support existing customers, but TI does not recommend using this part in a new design.

PREVIEW: Device has been announced but is not in production. Samples may or may not be available.

OBsolete: TI has discontinued the production of the device.

⁽²⁾ Eco Plan - The planned eco-friendly classification: Pb-Free (RoHS), Pb-Free (RoHS Exempt), or Green (RoHS & no Sb/Br) - please check <http://www.ti.com/productcontent> for the latest availability information and additional product content details.

TBD: The Pb-Free/Green conversion plan has not been defined.

Pb-Free (RoHS): TI's terms "Lead-Free" or "Pb-Free" mean semiconductor products that are compatible with the current RoHS requirements for all 6 substances, including the requirement that lead not exceed 0.1% by weight in homogeneous materials. Where designed to be soldered at high temperatures, TI Pb-Free products are suitable for use in specified lead-free processes.

Pb-Free (RoHS Exempt): This component has a RoHS exemption for either 1) lead-based flip-chip solder bumps used between the die and package, or 2) lead-based die adhesive used between the die and leadframe. The component is otherwise considered Pb-Free (RoHS compatible) as defined above.

Green (RoHS & no Sb/Br): TI defines "Green" to mean Pb-Free (RoHS compatible), and free of Bromine (Br) and Antimony (Sb) based flame retardants (Br or Sb do not exceed 0.1% by weight in homogeneous material)

⁽³⁾ MSL, Peak Temp. -- The Moisture Sensitivity Level rating according to the JEDEC industry standard classifications, and peak solder temperature.

Important Information and Disclaimer:The information provided on this page represents TI's knowledge and belief as of the date that it is provided. TI bases its knowledge and belief on information provided by third parties, and makes no representation or warranty as to the accuracy of such information. Efforts are underway to better integrate information from third parties. TI has taken and continues to take reasonable steps to provide representative and accurate information but may not have conducted destructive testing or chemical analysis on incoming materials and chemicals. TI and TI suppliers consider certain information to be proprietary, and thus CAS numbers and other limited information may not be available for release.

In no event shall TI's liability arising out of such information exceed the total purchase price of the TI part(s) at issue in this document sold by TI to Customer on an annual basis.

TAPE AND REEL INFORMATION



QUADRANT ASSIGNMENTS FOR PIN 1 ORIENTATION IN TAPE



*All dimensions are nominal

Device	Package Type	Package Drawing	Pins	SPQ	Reel Diameter (mm)	Reel Width W1 (mm)	A0 (mm)	B0 (mm)	K0 (mm)	P1 (mm)	W (mm)	Pin1 Quadrant
TPA6041A4RHBR	QFN	RHB	32	3000	330.0	12.4	5.3	5.3	1.5	8.0	12.0	Q2

TAPE AND REEL BOX DIMENSIONS



*All dimensions are nominal

Device	Package Type	Package Drawing	Pins	SPQ	Length (mm)	Width (mm)	Height (mm)
TPA6041A4RHBR	QFN	RHB	32	3000	346.0	346.0	29.0

RHB (S-PQFP-N32)

PLASTIC QUAD FLATPACK

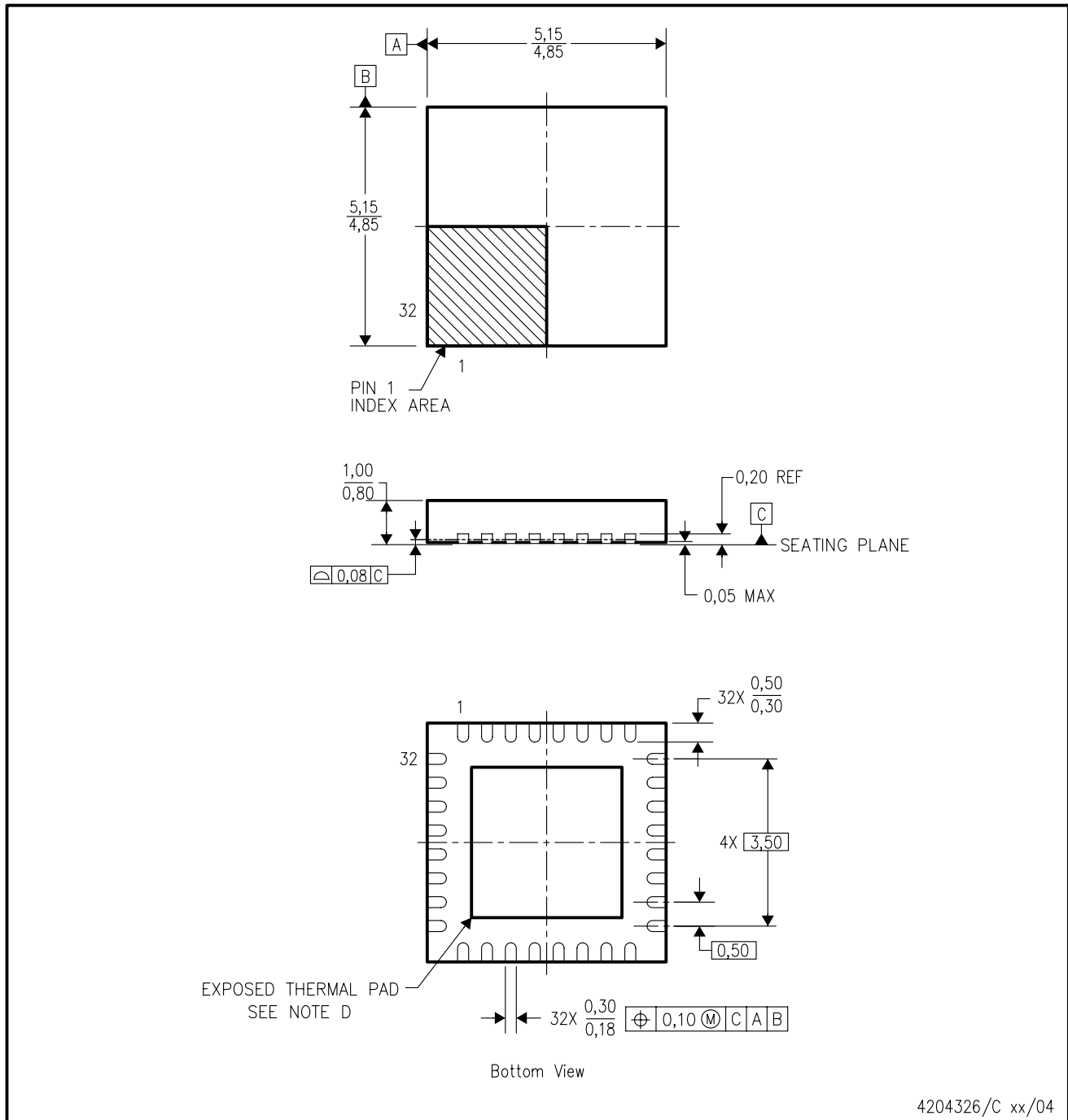

- NOTES:
- A. All linear dimensions are in millimeters.
 - B. This drawing is subject to change without notice.
 - C. QFN (Quad Flatpack No-Lead) Package configuration.
 - D. The Package thermal pad must be soldered to the board for thermal and mechanical performance. See product data sheet for details regarding the exposed thermal pad dimensions.
 - E. Falls within JEDEC MO-220.

THERMAL INFORMATION

This package incorporates an exposed thermal pad that is designed to be attached directly to an external heatsink. The thermal pad must be soldered directly to the printed circuit board (PCB). After soldering, the PCB can be used as a heatsink. In addition, through the use of thermal vias, the thermal pad can be attached directly to the appropriate copper plane shown in the electrical schematic for the device, or alternatively, can be attached to a special heatsink structure designed into the PCB. This design optimizes the heat transfer from the integrated circuit (IC).

For information on the Quad Flatpack No-Lead (QFN) package and its advantages, refer to Application Report, QFN/SON PCB Attachment, Texas Instruments Literature No. SLUA271. This document is available at www.ti.com.

The exposed thermal pad dimensions for this package are shown in the following illustration.

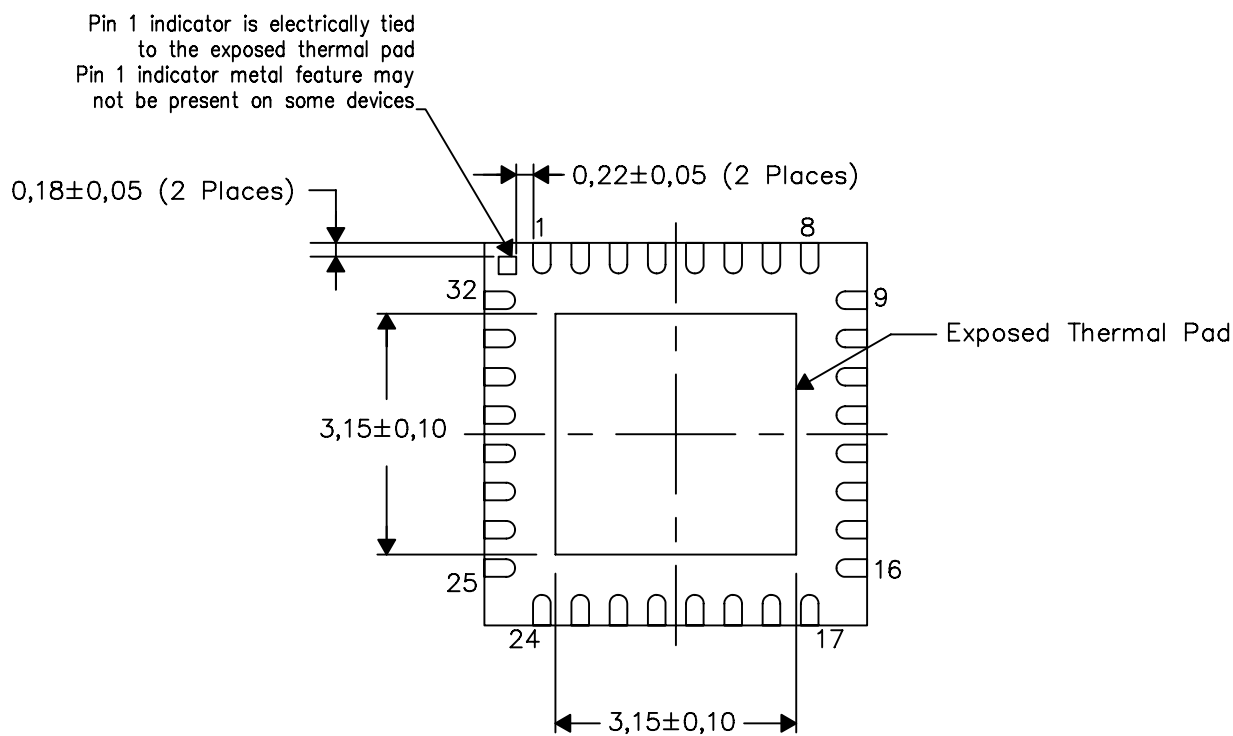

Bottom View

NOTE: All linear dimensions are in millimeters

Exposed Thermal Pad Dimensions

RHB (S-PQFP-N32)

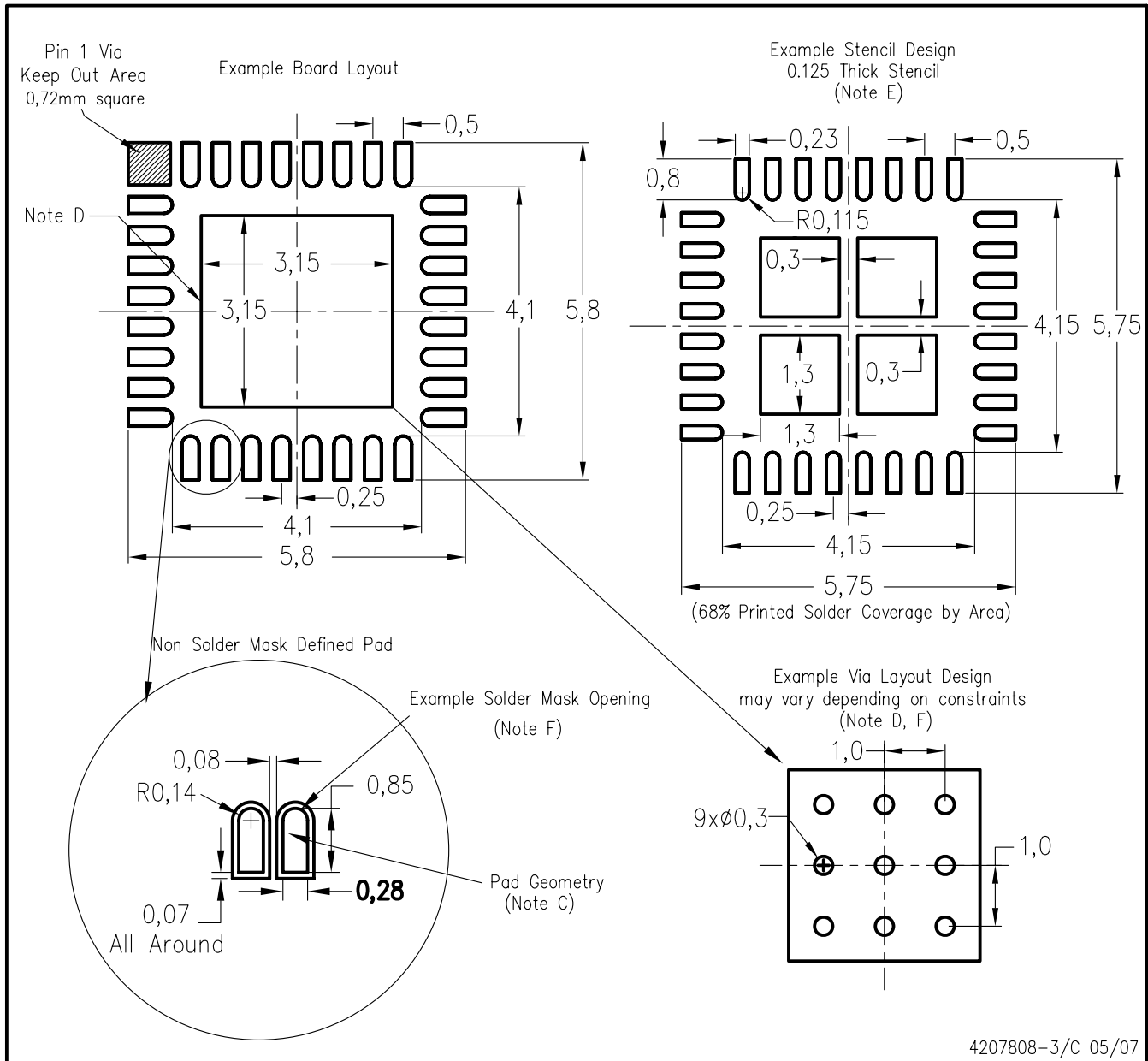

4207808-3/C 05/07

- NOTES:
- A. All linear dimensions are in millimeters.
 - B. This drawing is subject to change without notice.
 - C. Publication IPC-7351 is recommended for alternate designs.
 - D. This package is designed to be soldered to a thermal pad on the board. Refer to Application Note, Quad Flat-Pack Packages, Texas Instruments Literature No. SCBA017, SLUA271, and also the Product Data Sheets for specific thermal information, via requirements, and recommended board layout. These documents are available at www.ti.com <<http://www.ti.com>>.
 - E. Laser cutting apertures with trapezoidal walls and also rounding corners will offer better paste release. Customers should contact their board assembly site for stencil design recommendations. Refer to IPC 7525 for stencil design considerations.
 - F. Customers should contact their board fabrication site for recommended solder mask tolerances and via tenting recommendations for vias placed in the thermal pad.

IMPORTANT NOTICE

Texas Instruments Incorporated and its subsidiaries (TI) reserve the right to make corrections, modifications, enhancements, improvements, and other changes to its products and services at any time and to discontinue any product or service without notice. Customers should obtain the latest relevant information before placing orders and should verify that such information is current and complete. All products are sold subject to TI's terms and conditions of sale supplied at the time of order acknowledgment.

TI warrants performance of its hardware products to the specifications applicable at the time of sale in accordance with TI's standard warranty. Testing and other quality control techniques are used to the extent TI deems necessary to support this warranty. Except where mandated by government requirements, testing of all parameters of each product is not necessarily performed.

TI assumes no liability for applications assistance or customer product design. Customers are responsible for their products and applications using TI components. To minimize the risks associated with customer products and applications, customers should provide adequate design and operating safeguards.

TI does not warrant or represent that any license, either express or implied, is granted under any TI patent right, copyright, mask work right, or other TI intellectual property right relating to any combination, machine, or process in which TI products or services are used. Information published by TI regarding third-party products or services does not constitute a license from TI to use such products or services or a warranty or endorsement thereof. Use of such information may require a license from a third party under the patents or other intellectual property of the third party, or a license from TI under the patents or other intellectual property of TI.

Reproduction of TI information in TI data books or data sheets is permissible only if reproduction is without alteration and is accompanied by all associated warranties, conditions, limitations, and notices. Reproduction of this information with alteration is an unfair and deceptive business practice. TI is not responsible or liable for such altered documentation. Information of third parties may be subject to additional restrictions.

Resale of TI products or services with statements different from or beyond the parameters stated by TI for that product or service voids all express and any implied warranties for the associated TI product or service and is an unfair and deceptive business practice. TI is not responsible or liable for any such statements.

TI products are not authorized for use in safety-critical applications (such as life support) where a failure of the TI product would reasonably be expected to cause severe personal injury or death, unless officers of the parties have executed an agreement specifically governing such use. Buyers represent that they have all necessary expertise in the safety and regulatory ramifications of their applications, and acknowledge and agree that they are solely responsible for all legal, regulatory and safety-related requirements concerning their products and any use of TI products in such safety-critical applications, notwithstanding any applications-related information or support that may be provided by TI. Further, Buyers must fully indemnify TI and its representatives against any damages arising out of the use of TI products in such safety-critical applications.

TI products are neither designed nor intended for use in military/aerospace applications or environments unless the TI products are specifically designated by TI as military-grade or "enhanced plastic." Only products designated by TI as military-grade meet military specifications. Buyers acknowledge and agree that any such use of TI products which TI has not designated as military-grade is solely at the Buyer's risk, and that they are solely responsible for compliance with all legal and regulatory requirements in connection with such use.

TI products are neither designed nor intended for use in automotive applications or environments unless the specific TI products are designated by TI as compliant with ISO/TS 16949 requirements. Buyers acknowledge and agree that, if they use any non-designated products in automotive applications, TI will not be responsible for any failure to meet such requirements.

Following are URLs where you can obtain information on other Texas Instruments products and application solutions:

Products

Amplifiers	amplifier.ti.com
Data Converters	dataconverter.ti.com
DSP	dsp.ti.com
Clocks and Timers	www.ti.com/clocks
Interface	interface.ti.com
Logic	logic.ti.com
Power Mgmt	power.ti.com
Microcontrollers	microcontroller.ti.com
RFID	www.ti-rfid.com
RF/IF and ZigBee® Solutions	www.ti.com/lprf

Applications

Audio	www.ti.com/audio
Automotive	www.ti.com/automotive
Broadband	www.ti.com/broadband
Digital Control	www.ti.com/digitalcontrol
Medical	www.ti.com/medical
Military	www.ti.com/military
Optical Networking	www.ti.com/opticalnetwork
Security	www.ti.com/security
Telephony	www.ti.com/telephony
Video & Imaging	www.ti.com/video
Wireless	www.ti.com/wireless

Mailing Address: Texas Instruments, Post Office Box 655303, Dallas, Texas 75265
Copyright © 2008, Texas Instruments Incorporated